

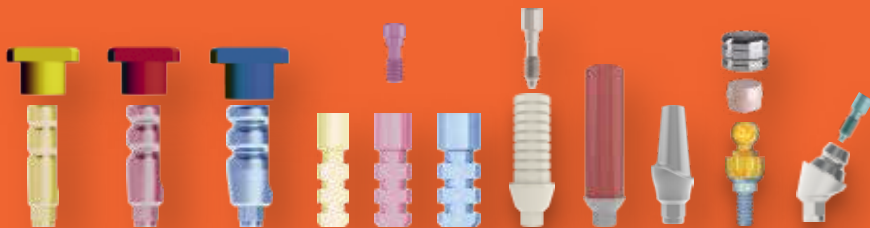

RatioPlant®

Dental implants 
Made in Germany

Prosthetics manual



Contents

Introduction	03
Overview of prosthetic components	04-05
Model production with open impression	06-07
Model production with closed impression	08-09
Temporary treatment	10-11
Titanium abutment treatment	12-13
Gold-plastic abutment screw treatment	14-15
Gold-plastic abutment cemented treatment	16-17
Titanium adhesive abutment treatment	18-19
Zirconium abutment treatment	20-21
Quick abutment treatment	22-23
Screwed bridge treatment (1)	24-25
Screwed bridge treatment (2)	26-27
Cemented bridge treatment (1)	28-29
Cemented bridge treatment (2)	30-31
MultiUnit abutments direct treatment	32-33
MultiUnit abutments indirect treatment	34-35
Bridge with MultiUnit abutments treatment (1)	36-37
Bridge with MultiUnit abutments treatment (2)	38-39
Telescopic crown treatment	40-41
Retentive anchor treatment	42-43
Equator direct treatment	44-45
Equator indirect treatment	46-47
Overview mini-platform	48-49
Prosthetic components mini-platform	50-51
Overview standard-platform	52-53
Prosthetic components standard	54-55
Overview large-platform	56-57
Prosthetic components large	58-59
Prosthetic components MultiUnit abutments and single	60-61
Prosthetic components hybrid prosthetic	62-63
Contact	64



Introduction

Our extensive experience in the field of human implantology and our expertise in the development, manufacture and testing of implants and instrument combinations guarantees the high functional use of all HumanTech products. In conjunction with the growing need to increase the quality of human life and the dynamic changes in the market, with increasing price and margin pressure, cost-orientated manufacture and distribution will assume more and more importance.

HumanTech is a corporate group, which is wholeheartedly committed to the use and manufacture of implants and instruments in the medical field, and develops and permanently seeks improved solutions.

We, as the manufacturer, eliminate unnecessary distribution costs by obtaining and distributing HumanTech products directly:

from development, to the finished product, right through to customer service - everything from a single source!

We manufacture, package and dispatch Ratioplant® dental implants directly to our customers in line with current directives.

The diversity of the RatioPlant® implant product line offers a wide range of clinical solutions, as well as reconstructions of single teeth, screwed or firmly cemented bridges and partial or full prostheses. You can also use RatioPlant® implants in all surgical and bone augmentation procedures, from the simplest to the most complex.

They are manufactured from biocompatible quality titanium and are at the cutting edge of science thanks to their blasted and etched surface.

All RatioPlant® implants fulfil the highest international standards. We are certified to DIN EN ISO 13485 as well as annex II of Directive 93/42/EEC.

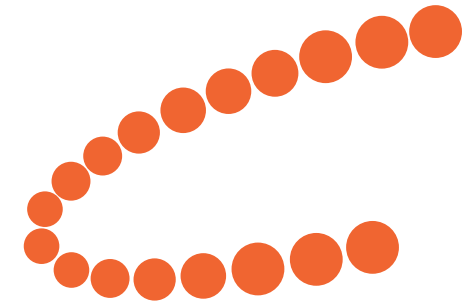

Overview of prosthetic components

Impression posts



RatioPlant impression posts are available for all platforms, for impression procedures with open or closed tray, as well as for making digital impressions. The perfectly harmonised components guarantee precise transfer of the oral situation to the master model or into the digital work environment.

Temporary abutments



Temporary abutments offer solutions for the temporary restoration of aesthetics, tissue contouring and immediate function. RatioPlant offers a wide range of temporary abutments for both screwed and cemented restorations.

Cementable abutments

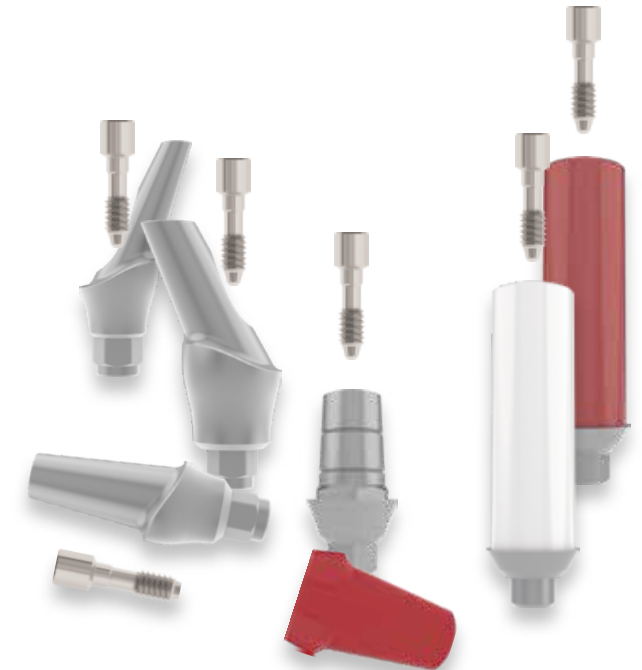

RatioPlant cemented abutments are available in a range of materials, forms, angles and sizes for all platforms in order to fulfil individual patient requirements.

Aesthetic abutments



Abutments hybrid prosthetics



MultiUnit abutments

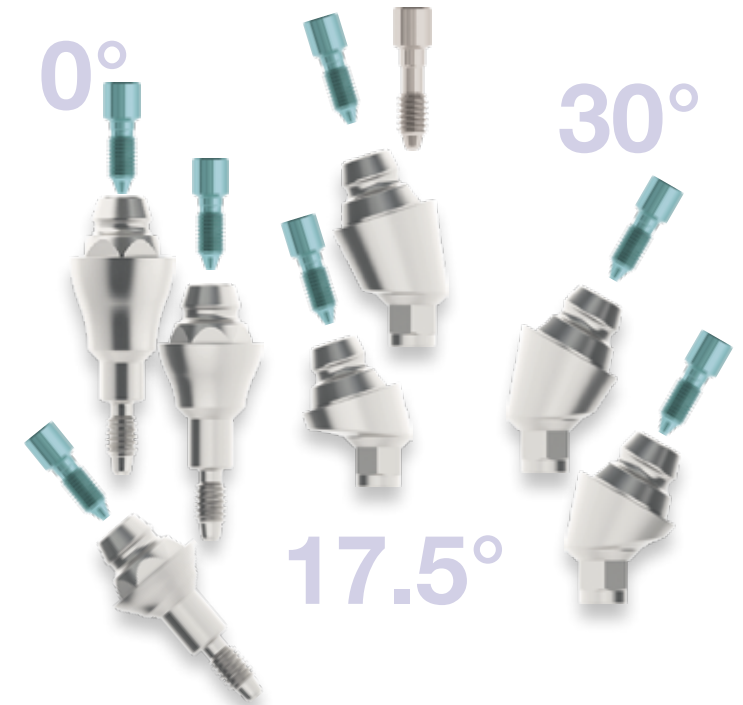

Abutments of sintered zirconium oxide for implementation of challenging and aesthetic dental prostheses. RatioPlant adhesive abutments were developed specifically for the manufacture of individual hybrid abutments consisting of a prefabricated Ti adhesive base and an individually manufactured zirconium or pressed ceramic base using suitable 2K adhesive and are ideally suited for high-quality front tooth restoration.

Implant-supported full prostheses can be used with a minimum of just two supporting implants, resulting in cost benefits for a number of patients. Equator and retentive anchors are ideal for the secure hold of prostheses in both the upper and lower jaw. These hybrid prostheses can also be easily managed by elderly patients and patients with disabilities.

The RatioPlant MultiUnit abutments solve challenging situations in the case of patients without teeth and offer a range of angles, shoulder heights and prosthetic components for individual and optimal treatment. The elaborate design ensures efficient treatment, including with immediate loading of the construction under the right conditions, and features an excellent system overview and a high degree of user friendliness.

Model production with open impression

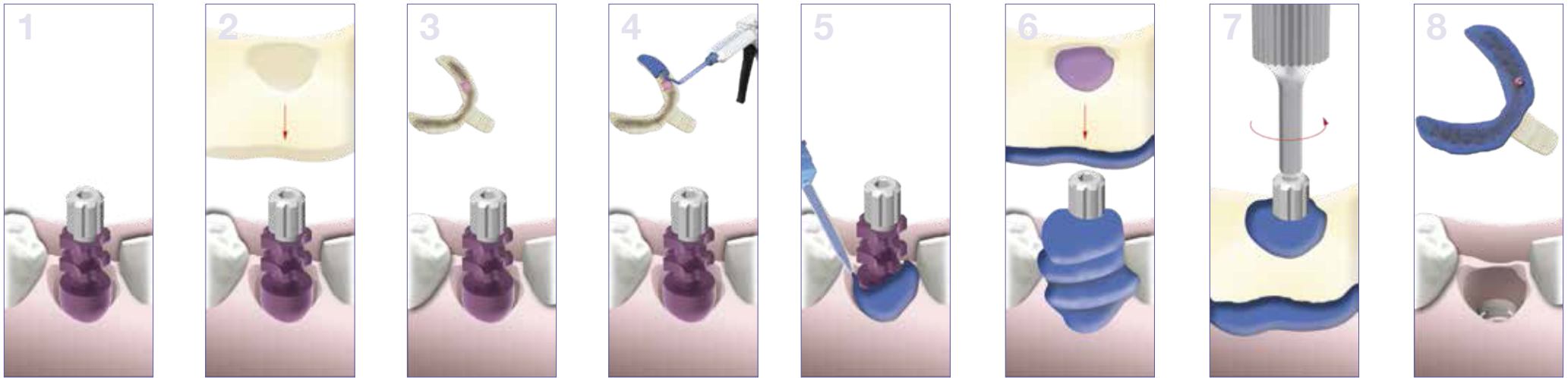

Steps

Place the impression posts for open impression with the enclosed long screws on the implant and hand tighten (1).

Test the appropriate impression tray (2).

Apply wax sheet or suitable foil on depression hole and apply suitable impression material to the impression tray (3-4).

Apply suitable impression material to the impression tray, then apply impression material with fine syringe into the sulcus area ensuring it is free of air pockets and place the prepared impression tray into position without tension (5-6).

Release the impression screw after the prescribed hardening time (7).

Remove the impression and prepare with a suitable disinfection agent (8).

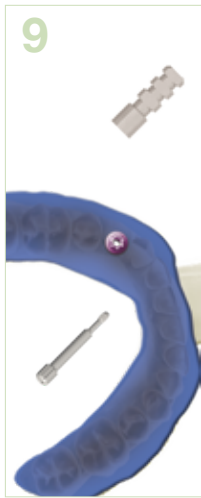

Hand tighten the impression posts with the corresponding laboratory analogue with the long screw (9-10).

Apply a gum collar made of suitable material if needed (11).

Empty the impression and base using model material (12-13).

To remove the impression from the model, unscrew the impression screw. Finished master model (14).

Essential prosthetic components and tools

1x Impression post incl. impression long screw

1x RatioPlant laboratory analogue M-S or L

1x Handheld hexagonal screwdriver



Model production closed impression

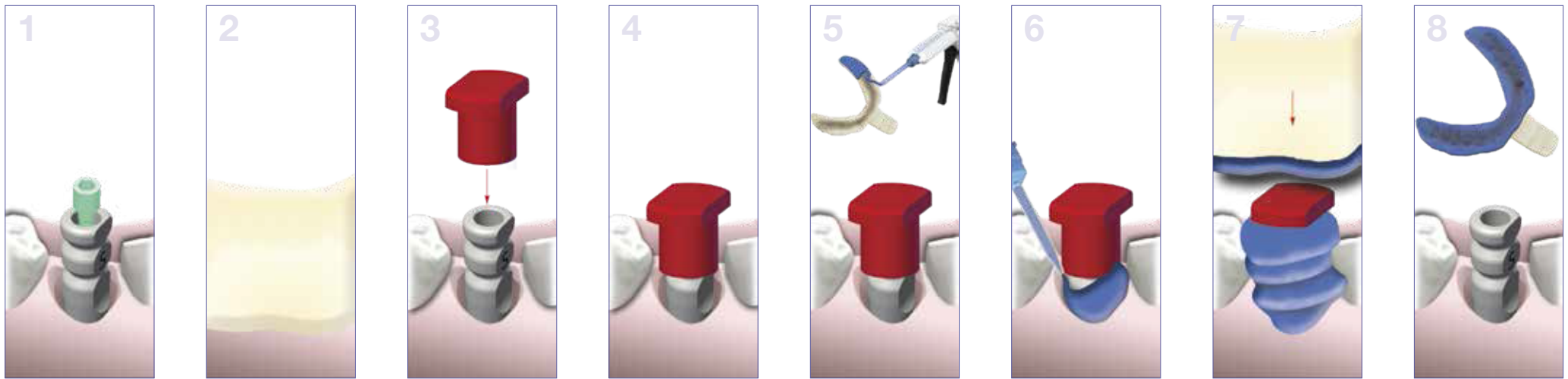

Steps

Place the impression posts for closed impression with the enclosed long screw on the implant and hand tighten (1).

Test the appropriate impression tray (2).

Apply plastic transfer cap and check that it is correctly fitted (3-4).

Apply suitable impression material to the impression tray (5).

Apply impression material with fine syringe into the sulcus area ensuring it is free of air pockets and place the prepared impression tray into position without tension (7-8).

Remove the impression after the stipulated hardening time and prepare with a suitable disinfection agent. Then loosen the impression posts and remove (8).

Hand tighten the impression posts with corresponding laboratory analogue with a laboratory screw (9).

Reposition impression posts into the impression with fitted laboratory analogue.

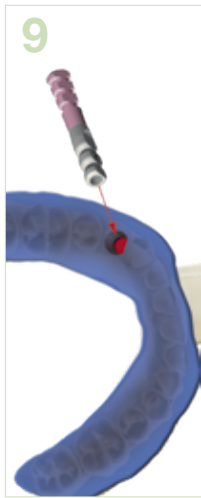

Ensure that the surface on the impression posts matches the corresponding surface in the impression exactly (10).

Apply a gum collar made of suitable material if needed (11).

Empty the impression and base using model material (12-13).

Finished master model (14).

Essential prosthetic components and tools

1x Impression post incl. prosthetic screw

1x RaitoPlant transfer cap M-S or L

1x Laboratory screw

1x RatioPlant laboratory analogue M-S or L

1x Handheld hexagonal screwdriver



Temporary treatment

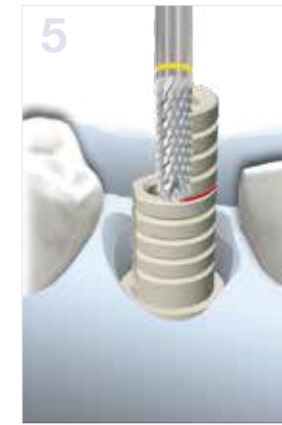

Steps

Model with model analogue (1).

Position the temporary Peek abutment corresponding to the implant diameter and hand tighten with a laboratory screw (violet) (2-3).

Mark the occlusal development on the model on the abutment, then remove the excess with a suitable milling cutter, to make enough space for the crown (4-5).

Trimmed temporary abutment (6).

Modelling of the wax crown. Attention should be paid to the placement of the screw

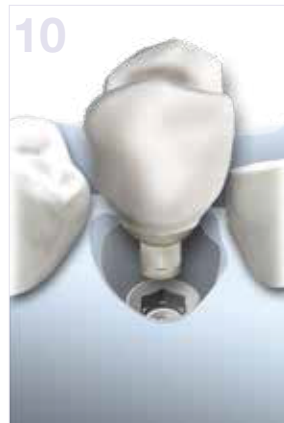
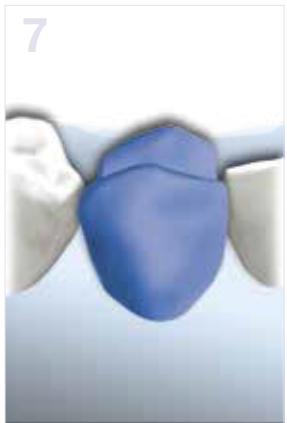

channel (opening to occlusal) (7).

After preparing a silicon key tooth form, supplement with suitable plastic material (8).

Abutment with crown prepared for implementation (9-10).

Finished temporary plastic crown with open screw channel is integrated with a prosthetic screw after cleaning (11-12).

Essential prosthetic components and tools

1x RatioPlant laboratory analogue M-S or L

1x Laboratory screw

1x Temporary Peek abutment incl. prosthetic screw

1x Handheld hexagonal screwdriver

1x Ratchet hexagonal screwdriver

1x Torque ratchet



Titanium abutment treatment



Steps

Model with model analogue (1).

Select titanium abutment corresponding to implant diameter, angles and depth of mucous membrane and hand tighten with a laboratory screw (violet) (2).

Mark the gingival margin on the model on the abutment, release laboratory screw and remove the abutment. Then remove the excess with a suitable milling cutter. We recommend use of a separate laboratory analogue for improved processing (3).

Affix to the model again with the laboratory screw (4).

Shorten from occlusal, to make more space for the crown (5).

Modelling of the wax or plastic crown (6).

Crown prepared for ceramic veneer after casting (7).

Finished ceramic crown (8).

After removal of the temporary treatment and cleaning, place the abutment in the mouth with the green prosthetic screw with the aid of the torque ratchet at a torque

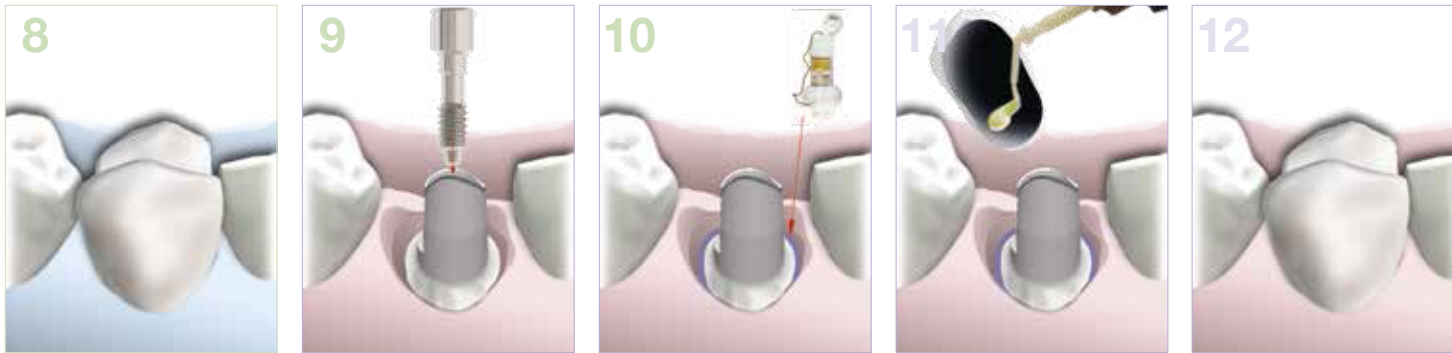

of max. 25Ncm. We recommend that you always use a new, intact prosthetic screw (9).

Always introduce a retraction thread to avoid the excess cement getting into the subgingival space (10).

Seal the screw channel on the abutment with a cotton pellet or similar before cementing. Mix suitable material for cementing and fill the crown (11).

Position the crown and allow it to harden with contact to the antagonist. Remove excess cement after the hardening time and clean the entire area (12).

Essential prosthetic components and tools

- 1x Laboratory screw
- 1x RatioPlant laboratory analogue M-S or L
- 1x Handheld hexagonal screwdriver
- 1x Torque ratchet
- 1x Ratchet hexagonal screwdriver
- 1x Titanium abutment corresponding to platform, angles and mucous membrane depth incl. 1x prosthetic screw (green)



Gold-plastic abutment screw treatment



Steps

Model with model analogue and gold-plastic abutment (1).

Position gold-plastic abutment corresponding to the implant diameter and hand tighten with a laboratory screw (violet) (2).

Mark the occlusal development on the model on the abutment, then remove the excess with a suitable milling cutter to create enough space for the crown (3).

Modelling of the wax and/or plastic crown. Attention should be paid to the placement of the screw channel (opening to occlusal) (4).

Release laboratory screw, remove entire model and prepare for casting (5-6).

Crown prepared for ceramic veneer after casting (7).

Finished ceramic crown with open screw channel (8).

Laboratory-fabricated inlay from suitable material (ceramic/composite) to close the screw channel (9-10).

After removal of the temporary treatment and cleaning, place the abutment in the mouth with the green prosthetic screw with the aid of the torque ratchet at a torque

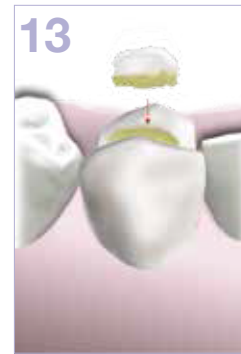
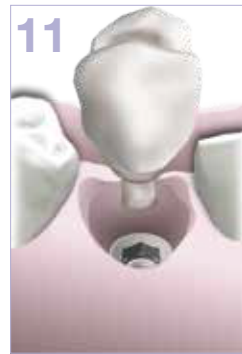

of max. 25Ncm. We recommend that you always use a new, intact prosthetic screw (11-12).

Seal the screw channel on the crown with a cotton pellet or similar before cementing the inlay. Mix suitable material for cementing (13).

Position inlay and allow to harden. Remove excess cement after the hardening time and clean the entire area (14).

Essential prosthetic components and tools

- 1x Laboratory screw
- 1x RatioPlant laboratory analogue M-S or L
- 1x Handheld hexagonal screwdriver
- 1x Torque ratchet
- 1x Ratchet hexagonal screwdriver
- 1x Gold-plastic abutment corresponding to platform, incl. 1x prosthetic screw (green)



Gold-plastic abutment cemented treatment



Steps

Model with model analogue and gold-plastic abutment (1).

Position gold-plastic abutment corresponding to the implant diameter and hand tighten with a laboratory screw (violet) (2).

Mark the occlusal development on the model on the abutment, then remove the excess with a suitable milling cutter to create enough space for the crown (3).

Modelling of the wax and/or plastic abutment. Attention should be paid to the placement of the screw channel (opening to occlusal) (4).

Release laboratory screw and remove entire model and prepare for casting (5-6).

Secondary crown prepared according to cast (7).

Modelling of the ceramic crown (8).

Finished ceramic crown with screw channel (9).

After removal of the temporary treatment and cleaning, place the abutment in the mouth with the green prosthetic screw with the aid of the torque ratchet at a torque of max. 25Ncm. We recommend that you always use a new, intact prosthetic screw (11-12).

Always introduce a retraction thread to avoid the excess cement getting into the subgingival space (10)!

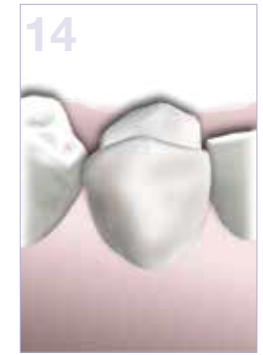
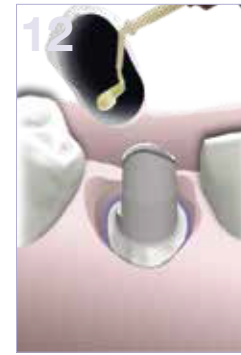
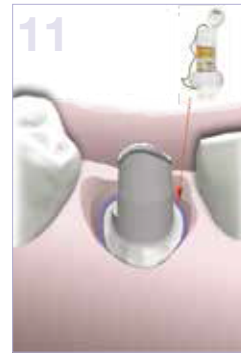
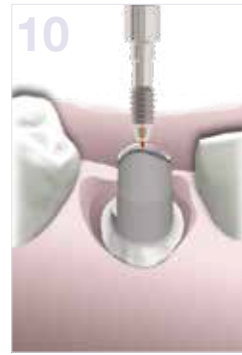

Seal the screw channel on the abutment with a cotton pellet or similar before cementing. Mix suitable material for cementing and fill the crown (11).

Position the crown and allow it to harden with contact to the antagonist. Remove excess cement after the hardening time and clean the entire area (12).

Essential prosthetic components and tools

- 1x Laboratory screw
- 1x RatioPlant laboratory analogue M-S or L
- 1x Handheld hexagonal screwdriver
- 1x Torque ratchet
- 1x Ratchet hexagonal screwdriver
- 1x Gold-plastic abutment corresponding to platform, incl. 1x prosthetic screw (green)



Titanium adhesive abutment treatment



Steps

Model with model analogue and titanium adhesive abutment (1).

Position titanium-adhesive abutment corresponding to the implant diameter and hand tighten with a laboratory screw (violet) (1).

Block the undercuts on the titanium-adhesive abutment with wax, apply suitable insulation agent, model the individual wax and/or plastic abutment and incorporate the screw channel (2).

Remove model and prepare for further processing (scan or pressing procedure) (3).

Affix the titanium-adhesive abutment with a laboratory screw to a laboratory analogue with 25 Ncm torque and condition the surface for adhesion (4). Place wax wire around the screw channel for protection before bonding the

zirconium or pressed ceramic abutment (5).

Bond the abutment with suitable composite-adhesive material (5-6).

Finished individual abutment with titanium adhesive base and open screw channel (7).

Preparation of a zirconium crown (8-10).

After removal of the temporary treatment and cleaning, place the abutment in the mouth with the green prosthetic screw with the aid of the torque ratchet at a torque of max. 25Ncm. We recommend that you always use a new, intact prosthetic screw (11-12).

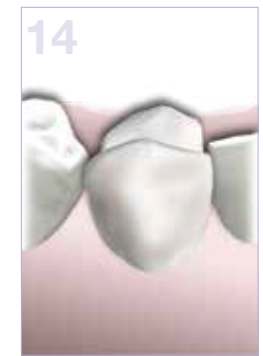

Seal the screw channel on the abutment with a cotton pellet or similar before cementing. Mix suitable material for cementing and fill the crown (13).

Always introduce a retraction thread to avoid the excess cement getting into the subgingival space (13)!

Position the crown and allow it to harden with contact to the antagonist. Remove retraction thread and excess cement after the hardening time and clean the entire area (14).

Essential prosthetic components and tools

- 1x Laboratory screw
- 1x RatioPlant laboratory analogue M-S or L
- 1x Handheld hexagonal screwdriver
- 1x Torque ratchet
- 1x Ratchet hexagonal screwdriver
- 1x Titanium-adhesive abutment corresponding to platform, incl. 1x prosthetic screw (green)



Zirconium abutment treatment

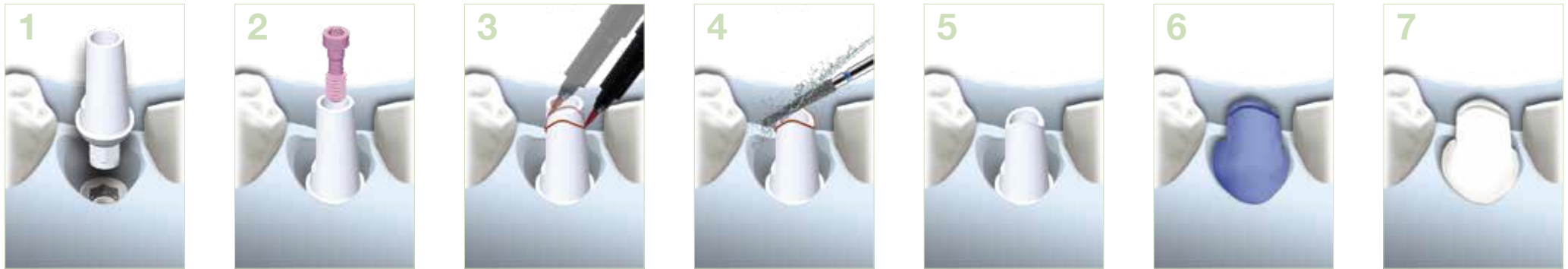

Steps

Model with model analogue and zirconium oxide abutment (1).

Position zirconium oxide abutment corresponding to the implant diameter and hand tighten with a laboratory screw (violet) (2).

Mark the occlusal development on the model on the abutment, then remove the excess with a suitable diamond cutter while water cooling, in order to make enough space for the crown (3-4).

Finished zirconium oxide crown with open screw channel (5).

Prepare model of zirconium oxide crown and further processing (scan or Cad-CAM) (6-7).

Preparation of a zirconium crown (8-9).

After removal of the temporary treatment and cleaning, place the zirconium oxide abutment in the mouth with the gold coloured prosthetic screw with the aid of the torque ratchet at a torque of max. 25Ncm. We recommend that you always use a new, intact prosthetic screw (10).

Seal the screw channel on the abutment with a cotton pellet or similar before cementing (11).

Always introduce a retraction thread to avoid the excess cement getting into the subgingival space (12)!

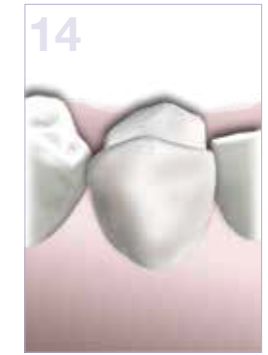
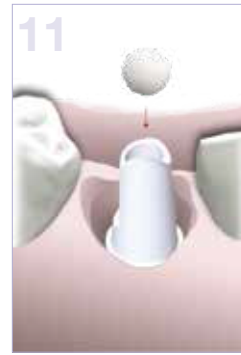

Mix suitable material for cementing and fill the crown (13).

Position the crown and allow it to harden with contact to the antagonist. Remove retraction thread and excess cement after the hardening time and clean the entire area (14).

Essential prosthetic components and tools

1x Laboratory screw

1x RatioPlant laboratory analogue M-S or L

1x Handheld hexagonal screwdriver

1x Torque ratchet

1x Ratchet hexagonal screwdriver

1x Zirconium oxide-abhesive abutment corresponding to platform, incl. 1x prosthetic screw (gold coloured)



Quick abutment treatment



Steps

Model with model analogue, quick abutment and laboratory screw (violet) (1).

Position quick cap corresponding to quick abutment (2).

Mark the occlusal development on the cap with a suitable milling cutter, to create enough space for the crown (3).

Modelling of the wax and/or plastic crown. Attention should be paid to the placement of the screw channel (opening to occlusal). Remove model and prepare for casting (4).

Crown prepared for ceramic veneer after casting (5).

Finished ceramic crown with open screw channel and laboratory-fabricated inlay made of suitable material (ceramic/composite) to close the screw channel (6).

Affix the quick abutment with a laboratory screw to a laboratory analogue with 25 Ncm torque and condition the surface for adhesion. Seal the screw channel with a cotton pellet for protection before adhesion of the crown (7). Bond the crown using suitable composite-adhesion material (8).

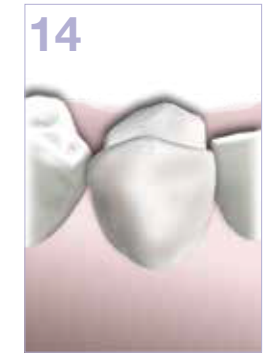
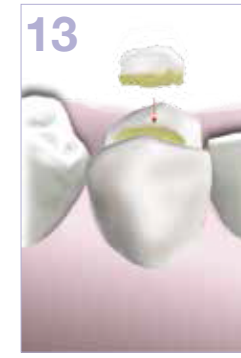
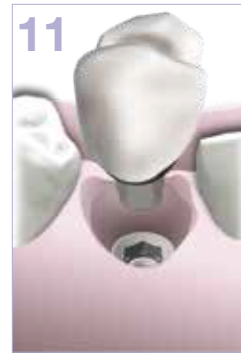
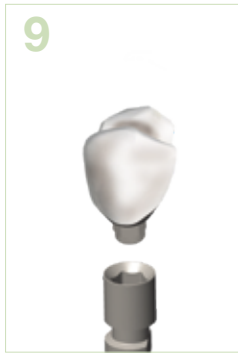

Finished crown with titanium abutment element and open screw channel (9-10).

After removal of the temporary treatment and cleaning, place the abutment in the mouth with the green prosthetic screw with the aid of the torque ratchet at a torque of max. 25Ncm. We recommend that you always use a new, intact prosthetic screw (11-12).

Seal the screw channel on the crown with a cotton pellet or similar before cementing the inlay. Mix suitable material for cementing (13).

Position inlay and allow to harden. Remove excess cement after the hardening time and clean the entire area (14).

Essential prosthetic components and tools

- 1x Laboratory screw
- 1x RatioPlant laboratory analogue M-S or L
- 1x Handheld hexagonal screwdriver
- 1x Torque ratchet
- 1x Ratchet hexagonal screwdriver
- 1x Quick abutment corresponding to platform, incl.
- 1x prosthetic screw (green) and 1x quick cap



Screwed bridge treatment (1)

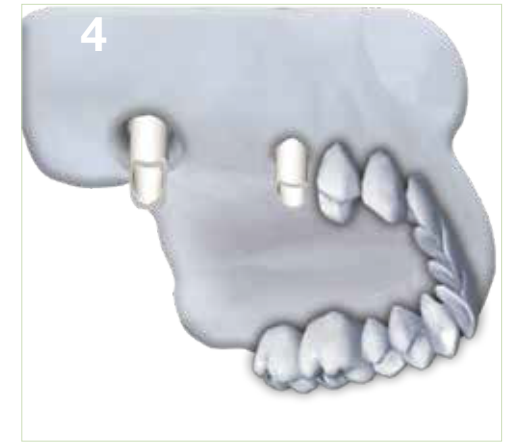
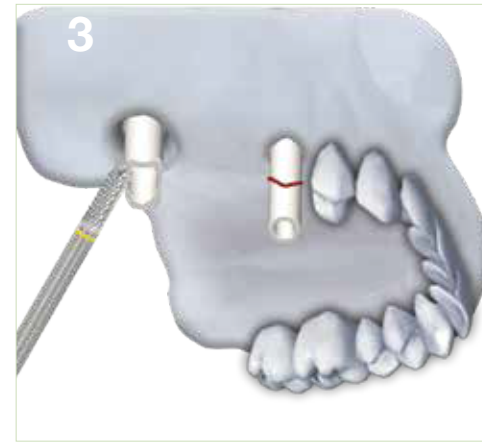
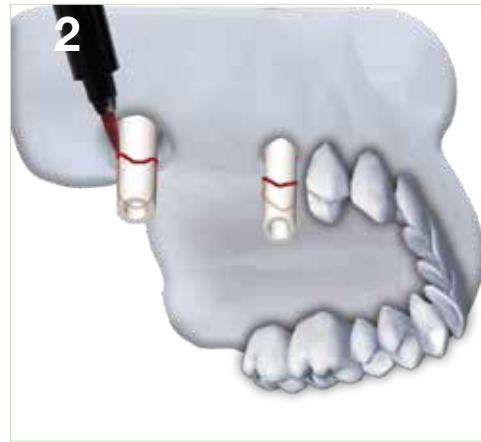

Steps

Model with model analogue and gold-plastic abutment. Position gold-plastic abutment corresponding to the implant diameter and hand tighten with a laboratory screw (violet) (1).

Mark the occlusal development on the model on the abutment, then remove the excess with a suitable milling cutter, to make enough space for the crown (2-4).

Modelling of the sulcus area (5).

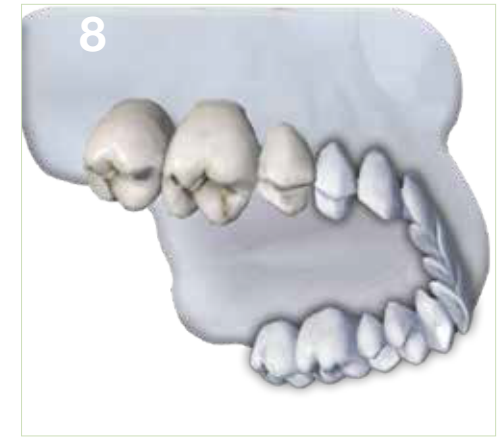
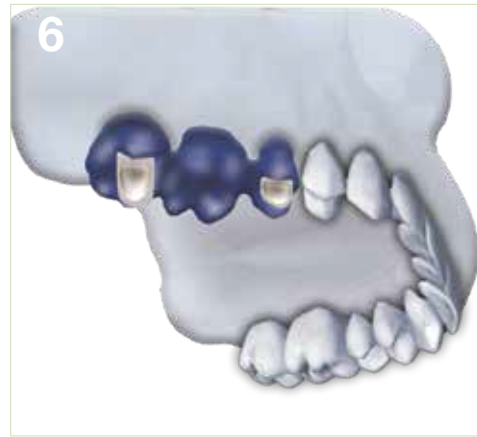

Modelling of the wax and/or plastic bridge frame. Attention should be paid to the placement of the screw channel (opening to occlusal) (6).

Release laboratory screw and remove entire model and prepare for casting (6).

Bridge frame prepared for ceramic veneer after casting (7).

Finished ceramic bridge with occlusal screw channel (8).

After removal of the temporary treatment and cleaning, place the abutment in the mouth with the green prosthetic screw with the aid of the torque ratchet at a torque

Screwed bridge treatment (2)

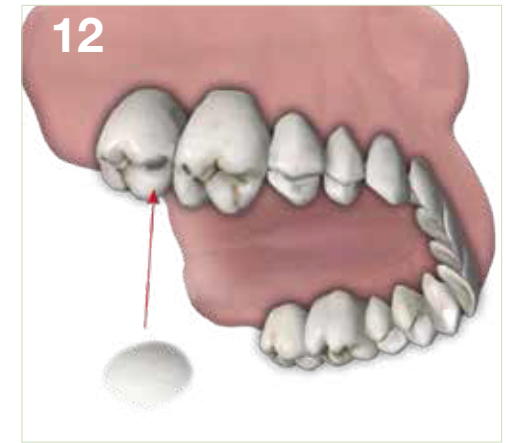
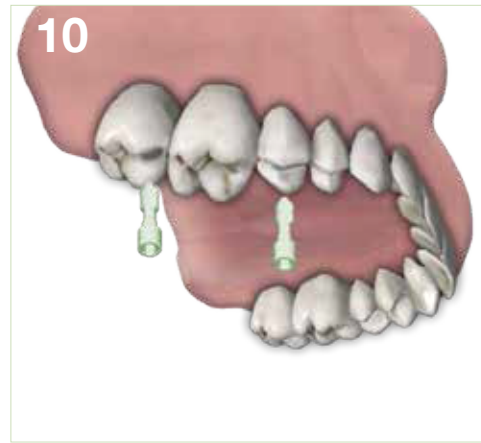
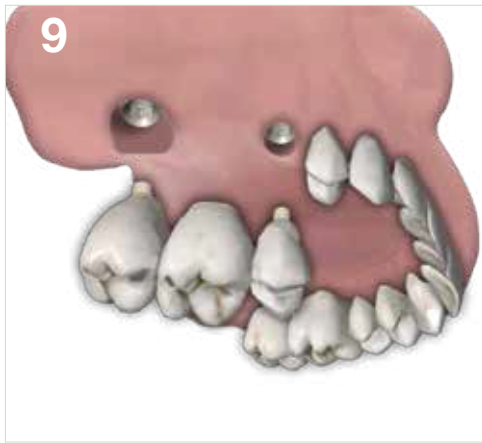

Steps

of max. 25Ncm. We recommend that you always use a new, intact prosthetic screw (9-11).

Seal the screw channel on the abutment with a cotton pellet or similar before cementing (12-13).

Mix suitable material for applying an occlusal filling and fill the crown (14-15).

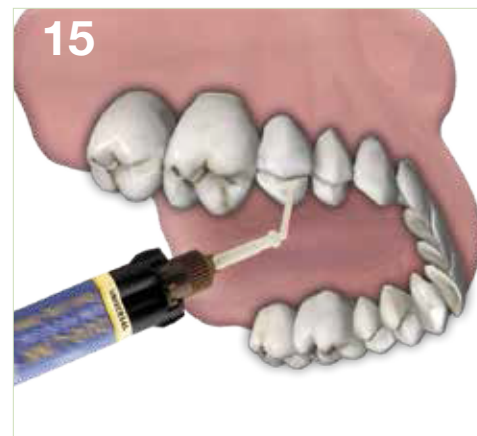
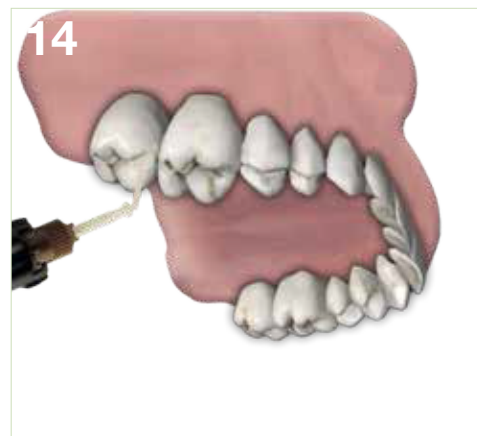

Remove excess cement after the hardening time, check occlusion and clean the entire area (12).

Essential prosthetic components and tools

2x Laboratory screws

1x RatioPlant laboratory analogue M-S or L

1x Handheld hexagonal screwdriver

1x Torque ratchet

1x Ratchet hexagonal screwdriver

2x Gold-plastic abutments without hexagon corresponding to platform, incl. 2x prosthetic screws (green)



Cemented bridge treatment (1)

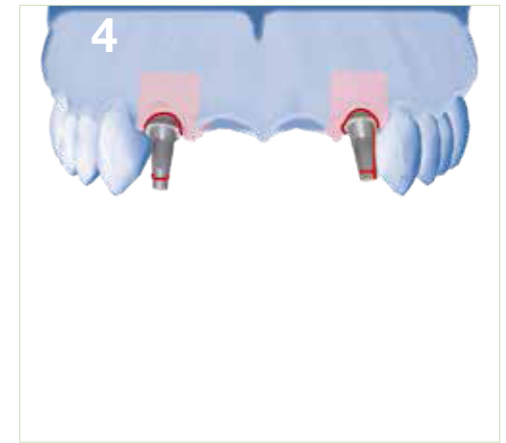
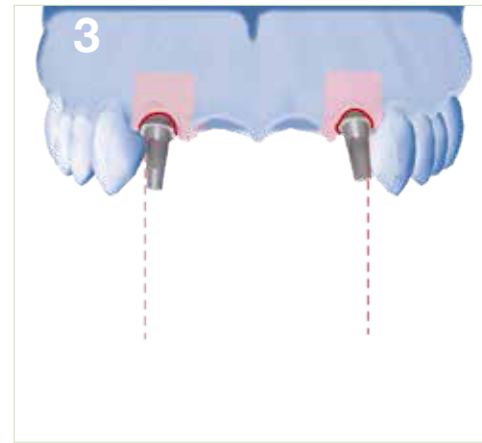
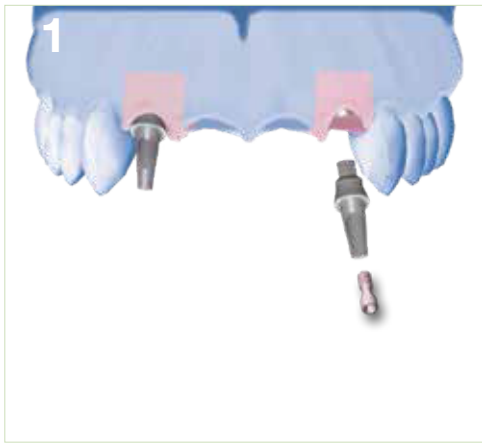

Steps

Model with model analogue and titanium abutment. Position titanium abutment corresponding to the angle and the implant diameter and hand tighten with a laboratory screw (violet) (1).

Mark the cervical development and parallelism on the model on the abutment, measure the model in the parallel meter (2-3).

Mark the length of the abutments (4).

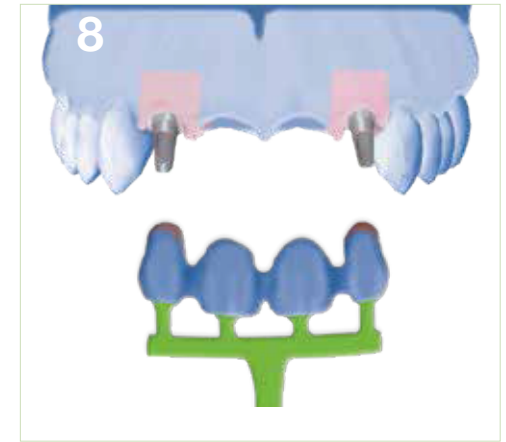
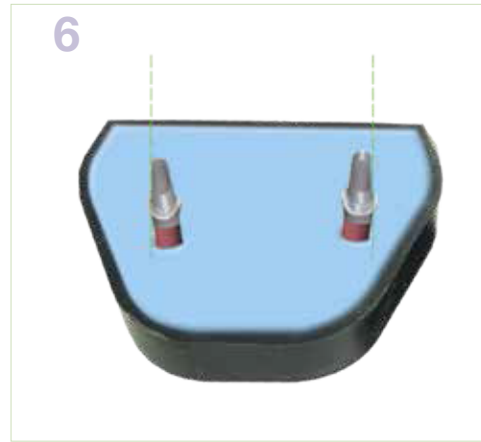
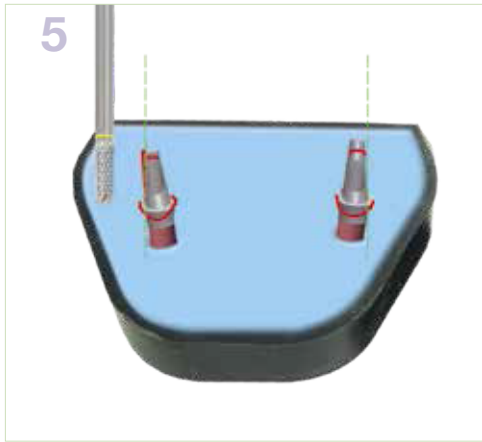

Transfer the abutments from the model to a milling model using a corresponding laboratory analogue. Remove the excess with a suitable milling cutter to create the optimal direction of insertion and moulding for the bridge (5-6).

Individualised titanium abutments (6).

Modelling of the wax and/or plastic bridge frame (7).

Attach casting channels, remove entire model and prepare for casting (8).
Bridge frame prepared for ceramic veneer after casting (9).

Cemented bridge treatment (2)

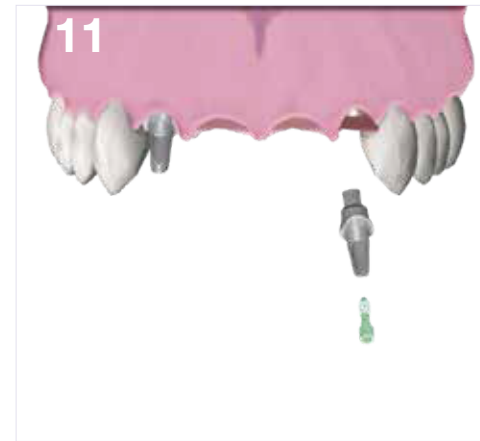
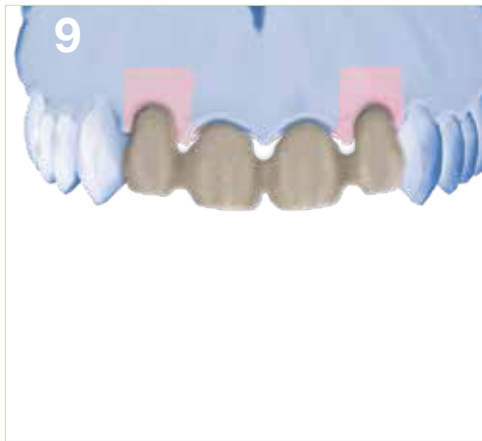

Steps

Finished ceramic bridge on the model (10).

After removal of the temporary treatment and cleaning, place the abutment in the mouth with the green prosthetic screw with the aid of the torque ratchet at a torque of max. 25Ncm. We recommend that you always use a new, intact prosthetic screw

(11).

Seal the screw channel on the abutment with a cotton pellet or similar before cementing (12).

Always introduce a retraction thread to avoid the excess cement getting into the subgingival space (13)!

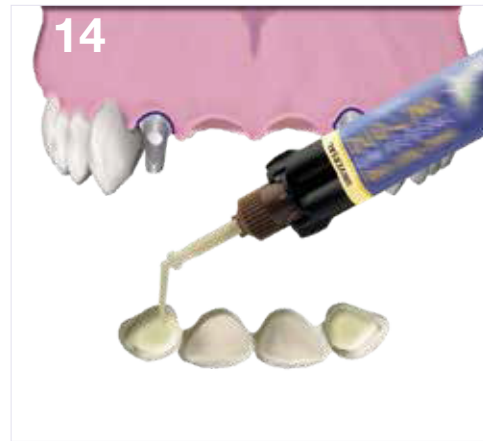

Fill suitable material into the crown for cementing (14).

Position bridge and allow to harden. Remove excess cement after the hardening time and clean the entire area (12).

Essential prosthetic components and tools

2x Laboratory screws

2+2x RatioPlant laboratory analogues M-S or L

1x Handheld hexagonal screwdriver

1x Torque ratchet

1x Ratchet hexagonal screwdriver

2x Titanium abutments corresponding to angles and platform, incl. prosthetic screws (green)



MultiUnit abutments direct treatment

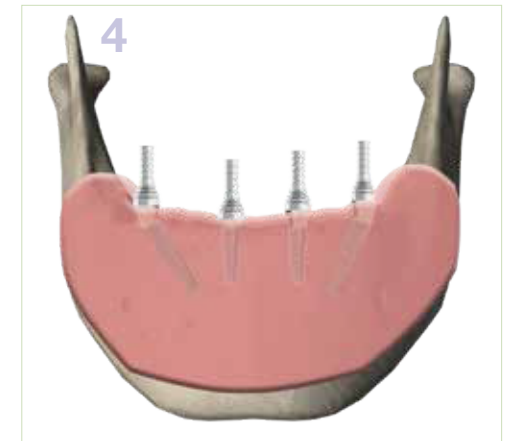
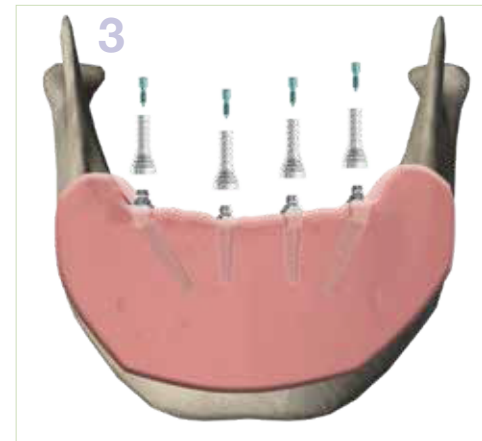
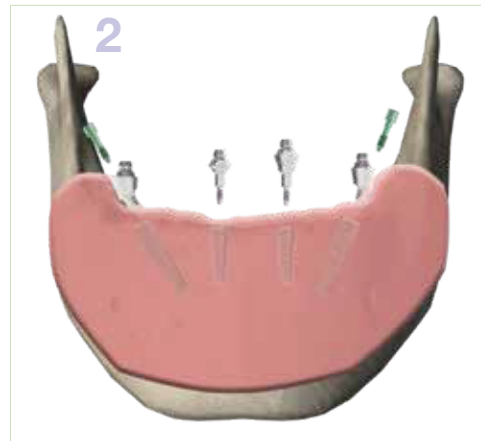

Steps

Implantation of RatioPlant® implants (1).

Screwing in of the straight MultiUnit titanium abutments with the MU inserter using the torque ratchet - torque 25Ncm. (2)

Positioning of the angled MultiUnit titanium abutments and fixing using the prosthetic screw with the ratchet hexagonal screwdriver and the torque ratchet - torque 25Ncm (2-3).

Positioning of the MU titanium prosthetic caps and fixing using the MU screw with a torque of 25Ncm (4).

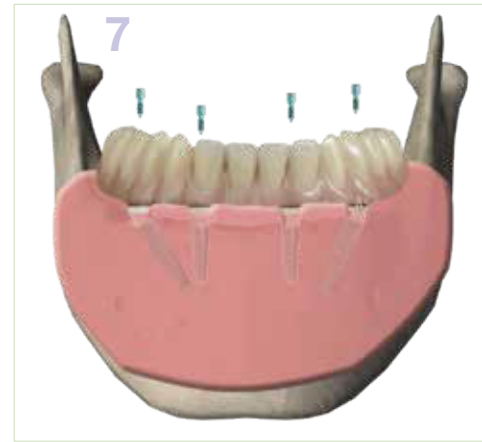

Bonding of the MultiUnit titanium abutments on the grounded off areas in the prosthesis with a suitable plastic material (5).

Shortening of the titanium abutment in order to adapt the screw channels to the development of the prosthesis. Finishing of the prosthesis (6).

Positioning of the prosthesis and fixing using the MultiUnit screw. Subsequent checking of the occlusion and function, as well as check of tension free fit of the secondary construction (7).

Essential prosthetic components and tools

1x MUA inserter ratchet

1x Torque ratchet

1x Ratchet hexagonal screwdriver

4x MU impression caps for closed impression

4x MU laboratory analogues

4x MultiUnit abutments corresponding to angles and platform, incl. 2x prosthetic screws (green)

4x MU prosthetic caps Ti, incl. 4x MU screws



MultiUnit abutments indirect treatment

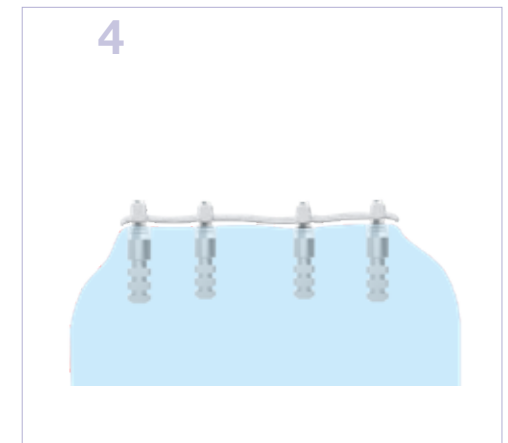
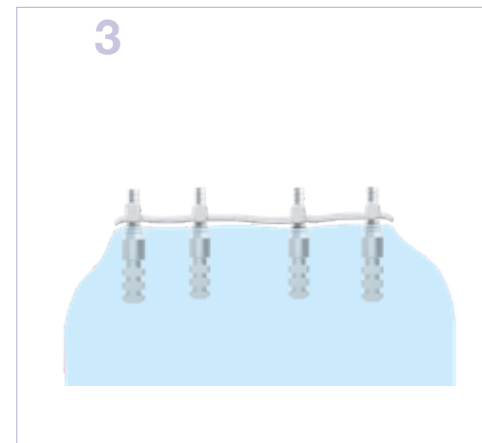
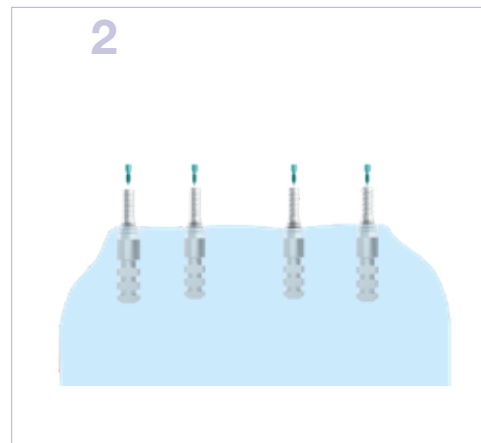
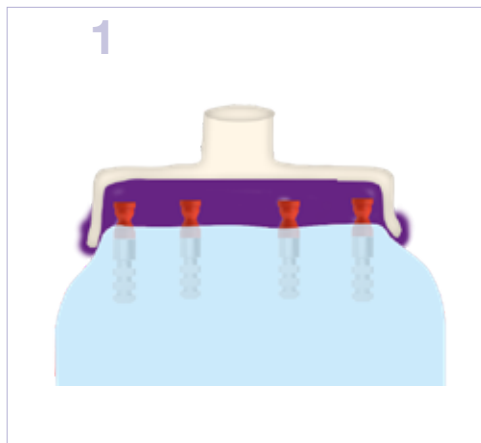

Steps

Impression taking using the MU impression caps, subsequent positioning of the MU laboratory analogue and model production (1).

Positioning of the MultiUnit titanium caps and fixing using the MU screws (2).

Creation of a suitable model casting base, for example for a prosthesis or a bridge frame (3).

Bonding of the MultiUnit titanium caps with the model casting base with a suitable two-component material on the model. It is also possible to carry out this step on patients in situ. (3)

Shortening of the MultiUnit Ti caps (4). Alternatively, these can also be shortened

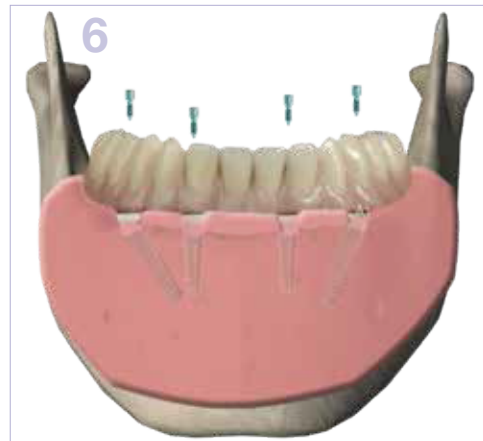

after production of the prosthesis, in order to adapt the screw channels to the prosthesis.

Finishing of the prosthesis (5).

Positioning of the prosthesis and fixing using the MultiUnit screw (6).

Subsequent checking of the occlusion and function, as well as check of tension free fit of the secondary construction (7).

Essential prosthetic components and tools

1x MUA inserter ratchet

1x Torque ratchet

1x Ratchet hexagonal screwdriver

4x MU impression caps for closed impression

4x MU laboratory analogues

4x MultiUnit abutments corresponding to angles and platform, incl. 2x prosthetic screws (green)

4x MU prosthetic caps Ti, incl. 4x MU screws

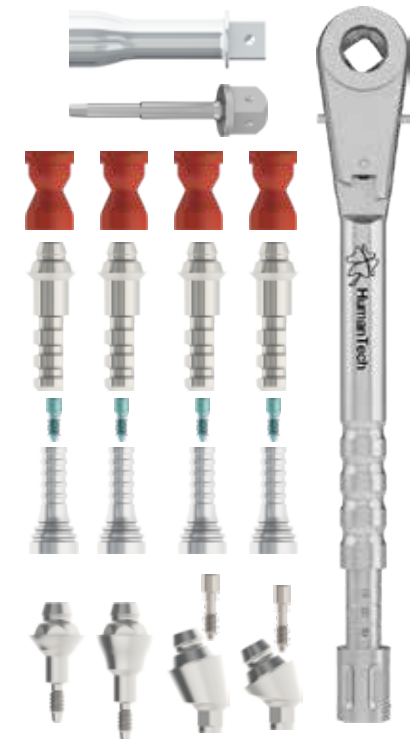

Bridge with MultiUnit abutments treatment (1)

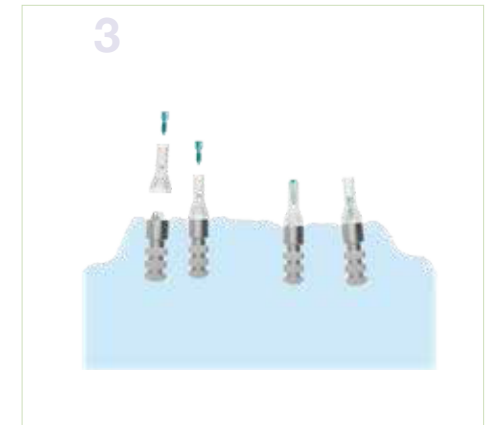
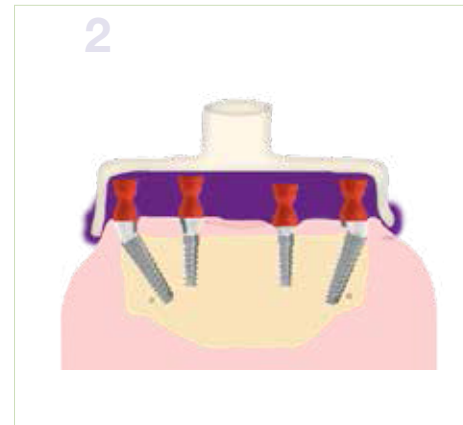
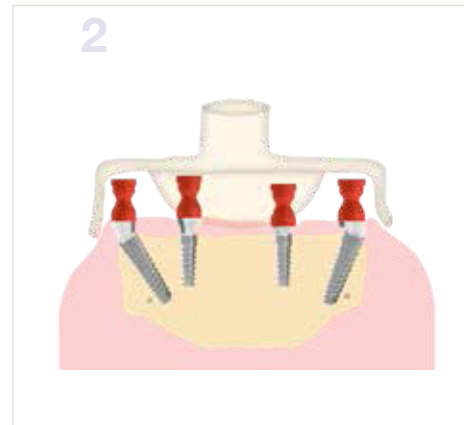
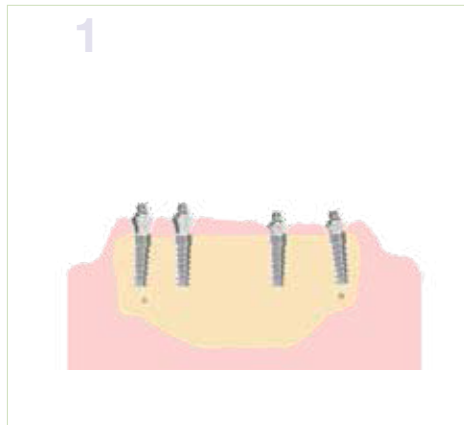

Steps

Place impression caps after the MultiUnit abutments have been positioned. Use suitable impression trays and create impression (1-2).

After the master model has been made using the laboratory analogues, position the modelling caps (plastic) and fix using the MUA prosthetic screws (3).



Modelling of the caps (4).
Modelling of the bridges (5).

Loosen the MUA prosthetic screws after attachment of the casting channels (6).

Bridge with MultiUnit abutments treatment (2)

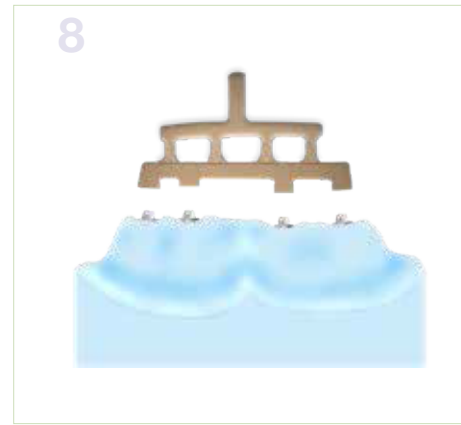

Steps

Remove wax/plastic construction and prepare for casting (7).

The construction cast in suitable alloy (8).

Position separate bridge construction tension free and fix to the model using the MUA prosthetic screws (9).

Finish bridge construction in the parallel milling device and as necessary attach corresponding friction elements (clips) (10).

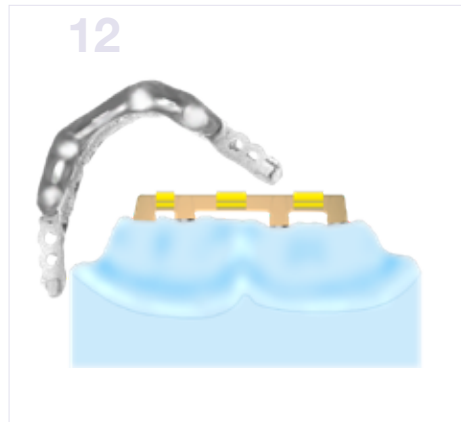

Make tertiary construction (11-12) and prepare for creation of a removable prosthesis (13).

Positioning of prosthetic teeth and modelling of the base (14).

Completion of the hybrid prosthesis with bridge support (15).

Essential prosthetic components and tools

1x MUA inserter ratchet

1x Torque ratchet

1x Ratchet hexagonal screwdriver

4x MU impression caps for closed impression

4x MU laboratory analogues

4x MultiUnit abutments corresponding to angles and platform, incl. 2x prosthetic screws (green)

4x MU prosthetic caps plastic, incl. 4x MU screws

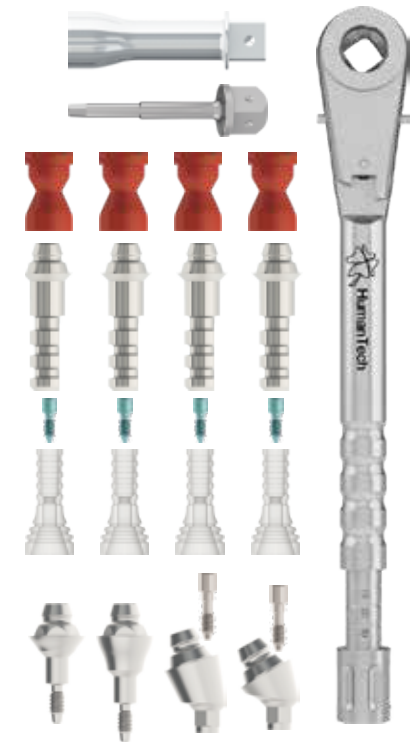

Telescopic crown treatment

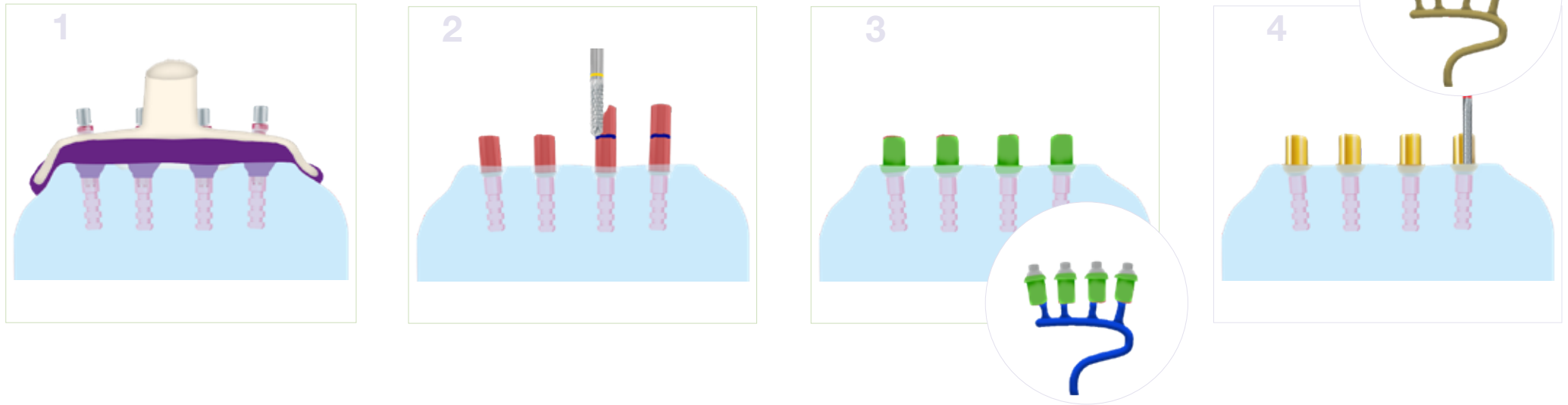

Steps

Making of impression preferably using the impression technique for open tray (1).

Produce a master model and position the gold-plastic abutments according to the implant platform on the model using the laboratory screws. After preparing the abutment length, reduce the plastic amount in the length and mill again in the parallel milling device according to the central insertion direction (2).

Supplement the desired form of the primary crowns with suitable milling wax and parallelise. Then embed and prepare for casting (3).

Develop cast abutments, mill in the parallel milling device and then polish and clean (4).

Produce, remove, embed and cast secondary caps using a suitable plastic material (5).

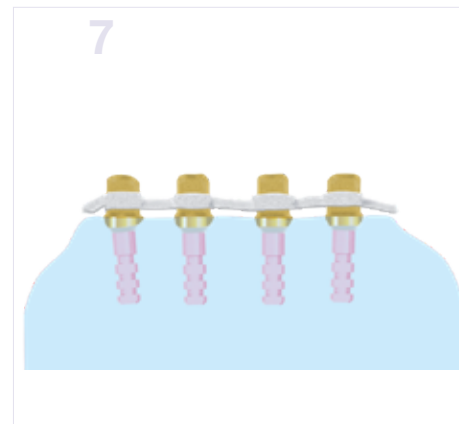
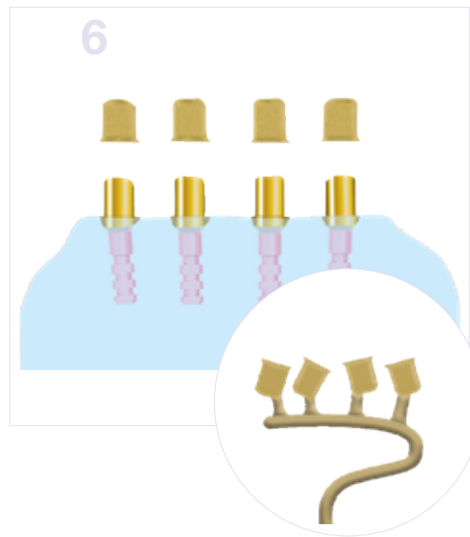
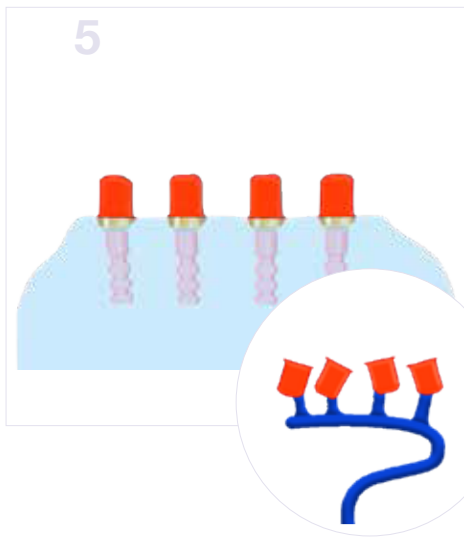

After drafting and testing the secondary crowns, apply these to the model (6).

Production of a model base subsequently on the model or, when testing on a patient, bond directly with the secondary crown (7).

Positioning of prosthetic teeth and modelling of the base. Completion of the hybrid prosthesis with telescope abutments and model cast base (8).

Essential prosthetic components and tools

1x Torque ratchet

1x Ratchet hexagonal screwdriver

4x Gold-plastic abutments corresponding to the implant platform M-S-L, including the respective prosthetic screws

4x MU laboratory analogues

4x Laboratory screws



Retentive anchor treatment

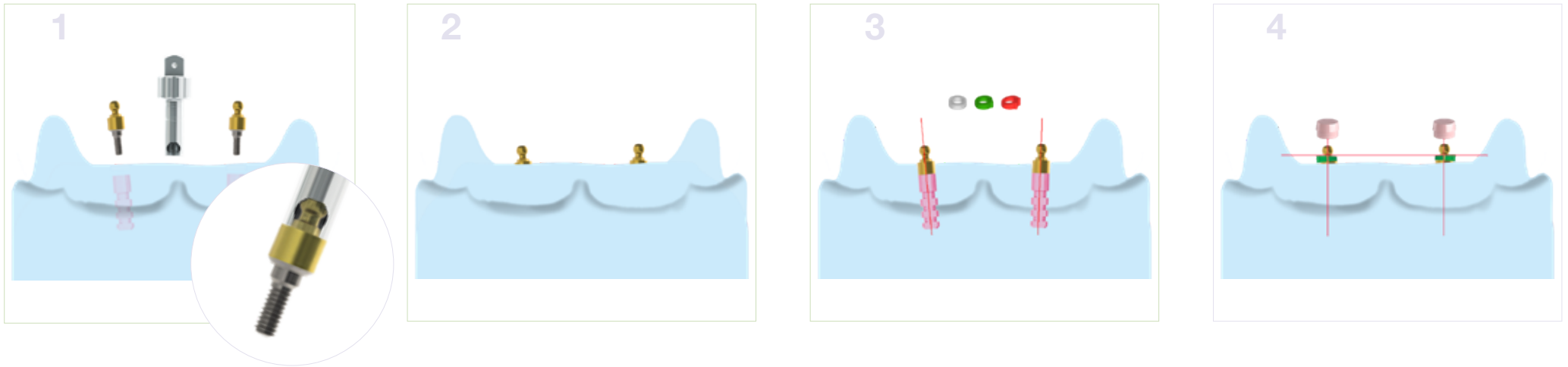

Steps

Once a master model has been created using the RatioPlant laboratory analogue, the SPHERO abutment is hand screwed into the intended implant using the appropriate instrument (ball abutment inserter) (1).

Placed ball anchor on the master model (2).

The alignment rings (3) in 0°, 7° and 14° are enclosed in the respective ball abutment set and are used for divergently positioned implants to correct the insertion direction of the prosthesis.

Position the alignment rings above the ball anchor on the abutment depending on the angle of the implants and bring into position by turning accordingly in order to create a level surface for the plastic caps (4).

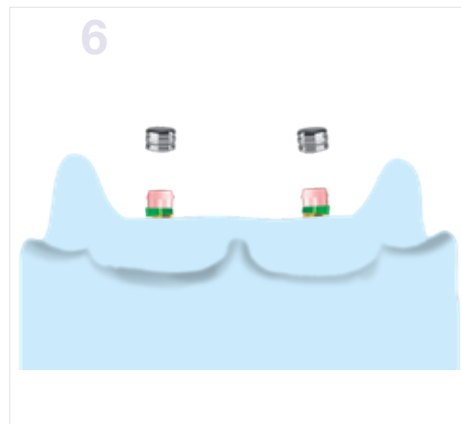
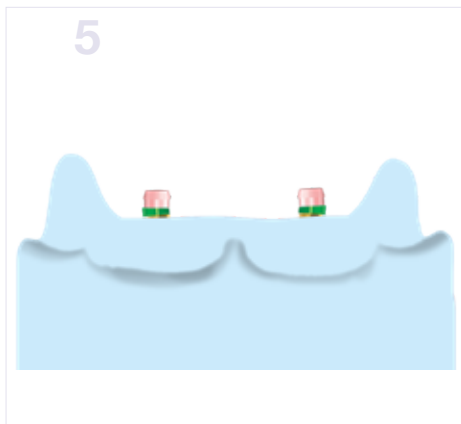

Position plastic caps and block the area under the caps with wax (5).

For easier exchange of the plastic caps following wear and tear, apply the metal casing (6).

If necessary, create a model cast base. Positioning of prosthetic teeth and modelling of the prosthetic base (7).

Completion of the hybrid prosthesis with retention anchor system (8).

Essential prosthetic components and tools

- 1x Ball abutment inserter ratchet
- 1x Torque ratchet
- 2x RatioPlant laboratory analogues S or L

2x SPHERO-FLEX sets corresponding to platform, each comprising: 1x Ball abutment

- A** 3x Alignment rings (0°, 7, 14°)
- 1x Metal casing
- 2x Pink-soft plastic caps

or

2x SPHERO-FLEX sets corresponding to platform, each comprising: 1x Ball abutment

- B** 3x Alignment rings (0°, 7, 14°)
- 1x Metal casing
- 2x Pink-soft plastic caps

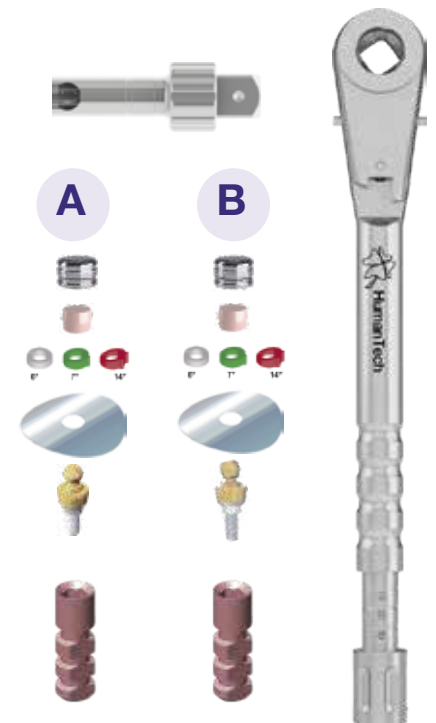

Equator direct treatment



Fitting directly on the patient

Screwing in of the Equator abutment in the intended implant using the Equator square screwdriver. Torque range between 22 and 25 Ncm.

RatioPlant Equator abutment used. Compatible with RatioPlant Classic and Avantgarde, mucous membrane heights are available in 1 mm - 7 mm.



Silicon discs are pushed over the Equator to protect the abutments, followed by the corresponding nylon caps with stainless steel casing. A range of Equator nylon caps with different friction degrees are available. Prosthesis prepared for inclusion of the stainless steel casing.

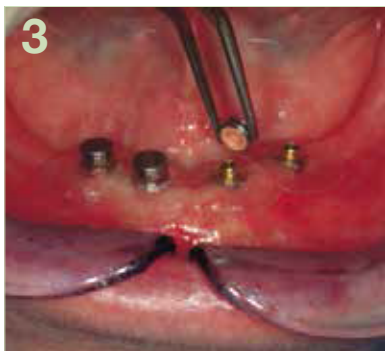

Mix suitable cold-cured polymer and apply to the prosthesis recesses, dry for a short period and position in the mouth.

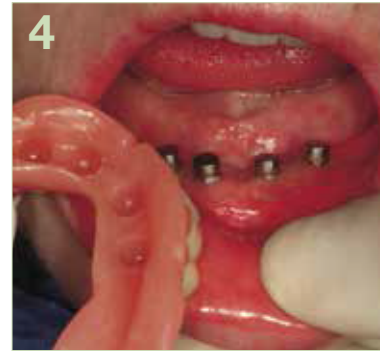

Matrices are affixed directly in the mouth.

Silicon discs are subsequently removed.



Remove excess plastic and finish prosthesis.

Prosthesis finished.

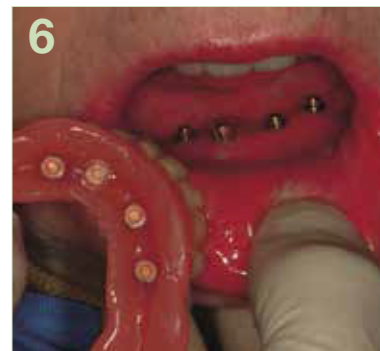



Essential prosthetic components and tools

4x Equator kits corresponding to the required mucous membrane height

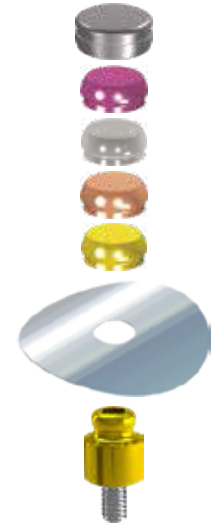

1x Equator inserter



1x Cap inserter



Equator indirect treatment



1 Fitting directly on the patient

Screwing in of the Equator abutment in the intended implant using the Equator square screwdriver. Torque range between 22 and 25 Ncm. Positioning of the impression caps with nylon cap.

Impression takes place with a closed tray.



2 Insert laboratory analogue.

Master model is finished and prepared for inclusion of the stainless steel casing.



3 Modelling of the prosthetic base.



4 Preparing for casting.

Position and block stainless steel casing with the black laboratory caps. Cast prosthesis base ready for bonding.



5 Bonding of the stainless steel casing in the prosthesis base with suitable two-component adhesive.

Prosthesis base with suitable laboratory caps.



6 Finished prosthesis with inserted nylon caps corresponding to the desired friction.



Essential prosthetic components and tools

2x Equator impression caps

2x Equator laboratory analogues

2x Equator kits corresponding to the required mucous membrane height

1x Equator inserter

1x Cap inserter



Overview mini-platform

Mini



Classification



Impression

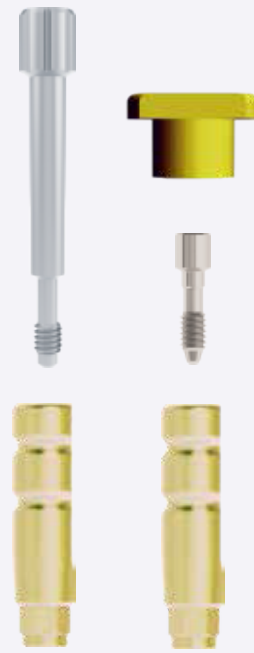

Model



Temporary measure Titanium abutment



Titanium abutment

Adhesive abutment



0°
15°
25°



Prosthetic components mini platform

Prosthetic screw head normal	5011109001	
Laboratory screw	5011109004	
Prosthetic screw for zirconium abutment	5011109005	
Long screw for impression	5011109006	
Impression posts open impression mini Standard incl. long screw	5011105030	
Impression posts closed impression mini incl. prosthetic screw and transfer cap	5011105031	
Model analogue mini	5011110000	

Titanium abutment mini 0 conical H1 Titanium abutment mini 0 conical H2 Titanium abutment mini 0 conical H3 each incl. prosthetic screw	5011110170 5011110270 5011110070	
Titanium abutment mini 15 angled H1 Titanium abutment mini 15 angled H2 Titanium abutment mini 15 angled H3 each incl. prosthetic screw	5011110180 5011110280 5011110080	
Titanium abutment mini 25 angled H1 Titanium abutment mini 25 angled H2 Titanium abutment mini 25 angled H3 each incl. prosthetic screw	5011110190 5011110290 5011110090	
Quick abutment mini incl. prosthetic screw	5011110009	
Quick plastic cap mini, combustible	5011210061	

Mini

mm	h1	h2	h3
h	9.6	11.0	13.0
hl	2.5	4.0	5.5
hb	1.5	2.5	4.5
d1	3.25		
d2	4.25		

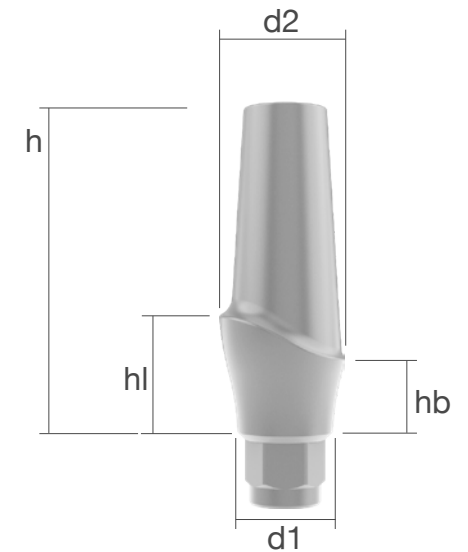

AVANTGARDE Mini



Ø3.2

Platform - Mini

for implants with a diameter of 3.2 mm

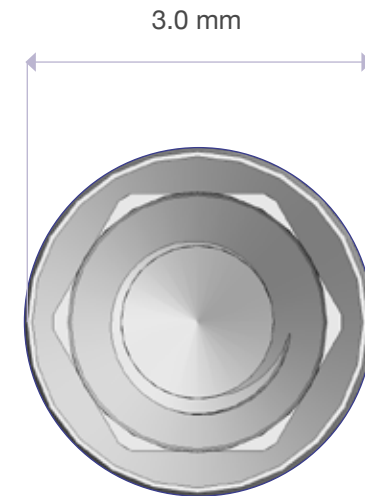

Overview standard-platform

Standard

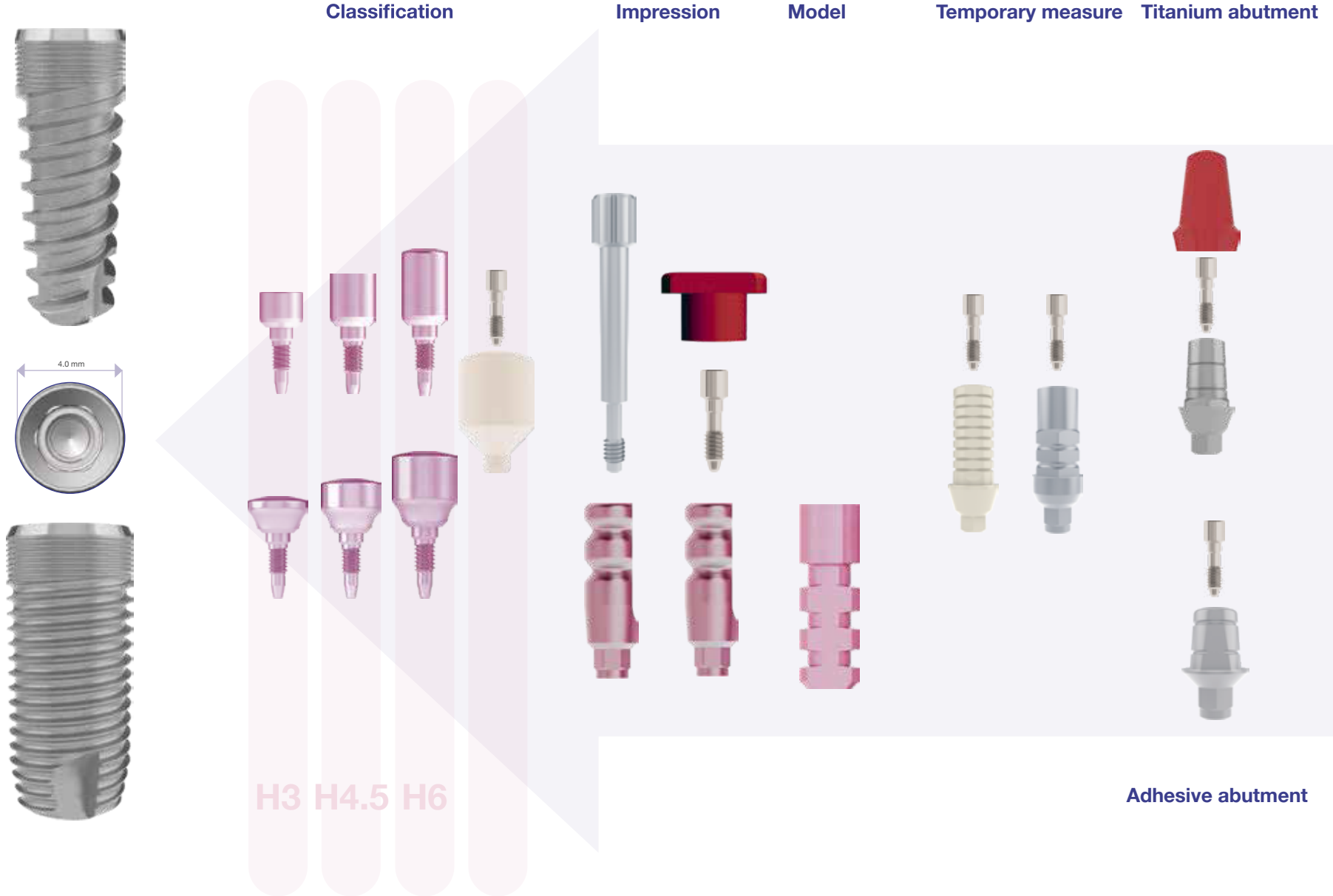

Titanium abutment

Zirconium abutment

Cast abutment

Hybrid prosthetics

MultiUnit treatment

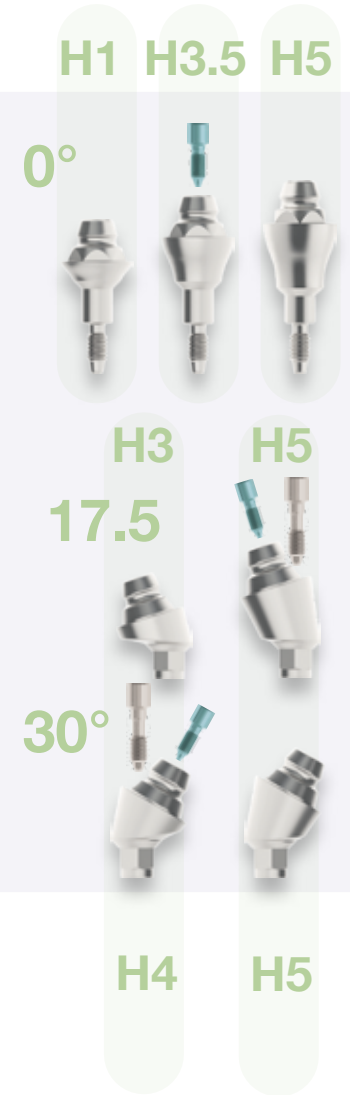
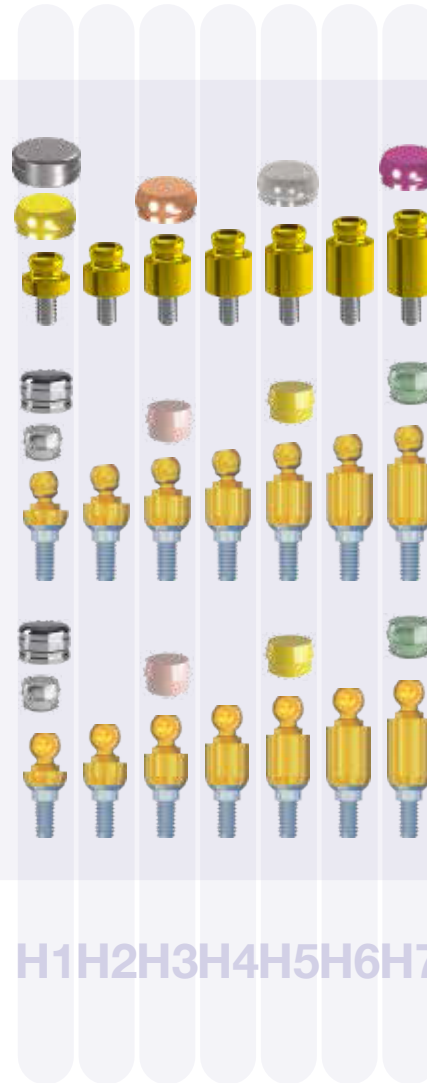

Prosthetic components standard platform

Prosthetic screw head normal	5011109001	
Laboratory screw	5011109004	
Prosthetic screw for zirconium abutment	5011109005	
Long screw for impression	5011109006	
Impression posts open impression Standard incl. long screw	5011105001	
Impression posts closed impression standard incl. prosthetic screw and transfer cap	5011105005	
Model analogue standard	5011110001	

Titanium abutment standard 0° conical H1 Titanium abutment standard 0° conical H2 Titanium abutment standard 0° conical H3 each incl. prosthetic screw	5011110120 5011110220 5011110020	
Titanium abutment standard 15° angled H1 Titanium abutment standard 15° angled H2 Titanium abutment standard 15° angled H3 each incl. prosthetic screw	5011110130 5011110230 5011110030	
Titanium abutment standard 25° angled H1 Titanium abutment standard 25° angled H2 Titanium abutment standard 25° angled H3 each incl. prosthetic screw	5011110140 5011110240 5011110040	
Quick abutment standard incl. prosthetic screw Quick plastic cap, combustible	5011110010 5011210060	
Zirconium abutment standard 0° conical aesthetics Zirconium abutment standard 15° conical aesthetics Zirconium abutment standard 25° conical aesthetics each incl. ZiO prosthetic screw	5011410022 5011410032 5011410042	

Standard

mm	h1	h2	h3
h	9.6	11.0	13.0
h1	2.5	4.0	5.5
hb	1.5	2.5	4.5
d1	3.75		
d2	4.38		

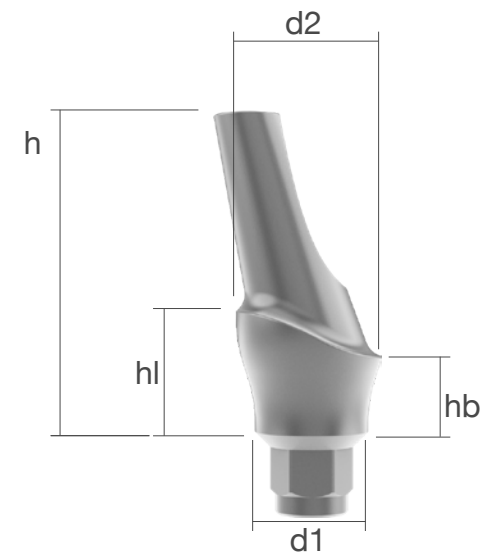

Gold-plastic abutment standard without hexagon incl. prosthetic screw	5011510001	
Gold-plastic abutment standard with hexagon incl. prosthetic screw	5011510002	
Plastic abutment standard without hexagon incl. prosthetic screw	5011210001	
Plastic abutment standard with hexagon incl. prosthetic screw	5011210002	
PEEK abutment for temporary treatment standard incl. prosthetic screw	5011610101	
Titanium abutment for temporary treatment standard incl. prosthetic screw	5011110101	
Ti adhesive base standard incl. prosthetic screw	5011110050	

Platform - Standard

for implants with a diameter of 3.8 mm and 4.2 mm

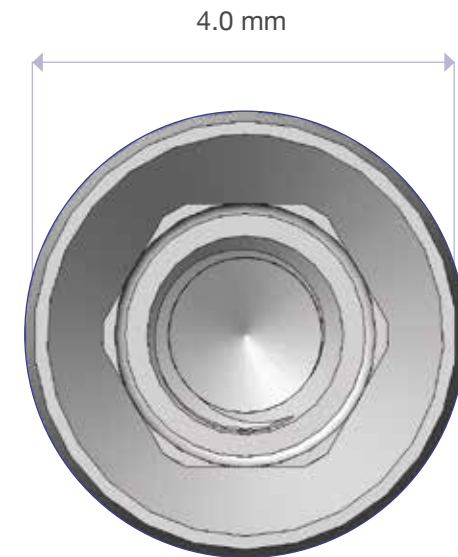

Ø3.8 and 4.2

Overview large-platform

Large

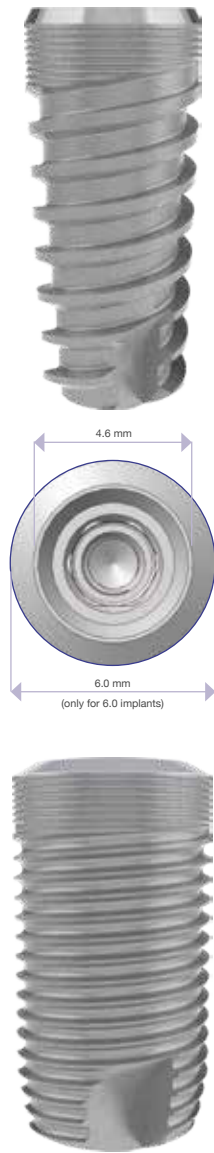

Classification



Impression



Model



Temporary measure Titanium abutment



Adhesive abutment

Titanium abutment

Zirconium abutment

Cast abutment

Hybrid prosthetics

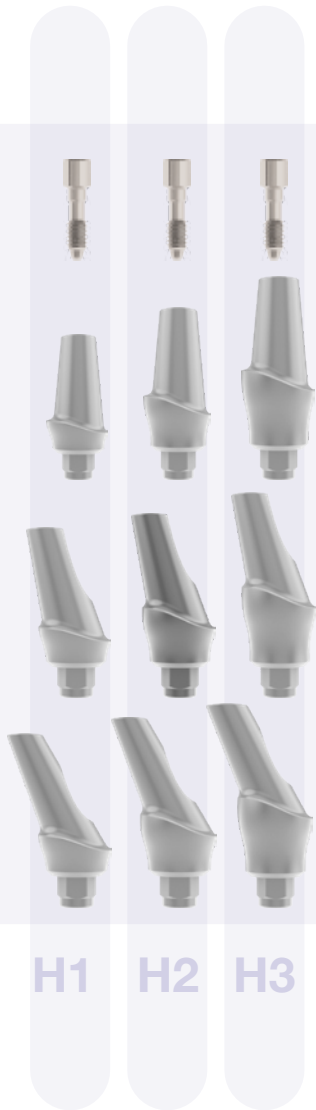

0°
15°
25°

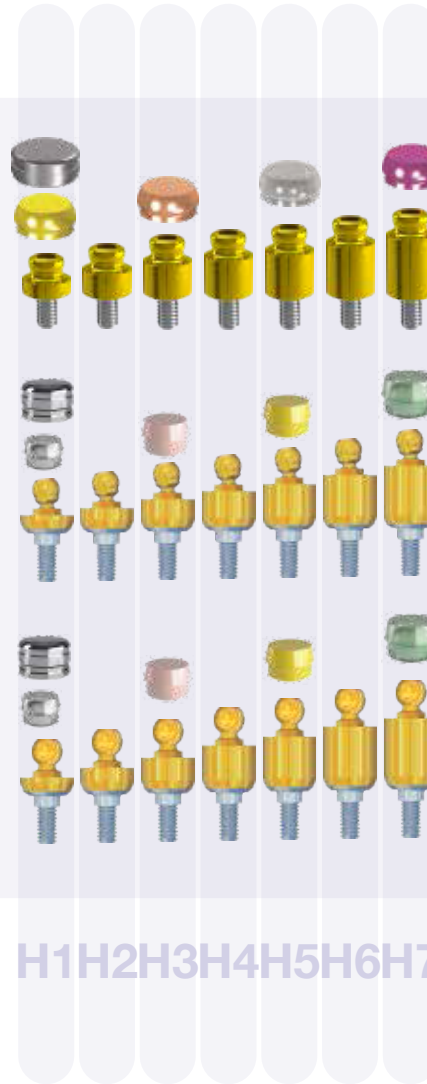

H1 H2 H3 H4 H5 H6 H7

Prosthetic components large platform

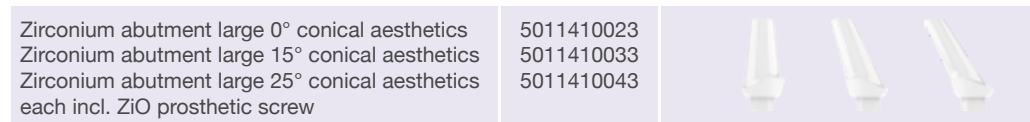
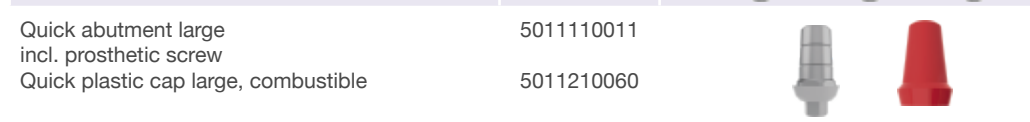
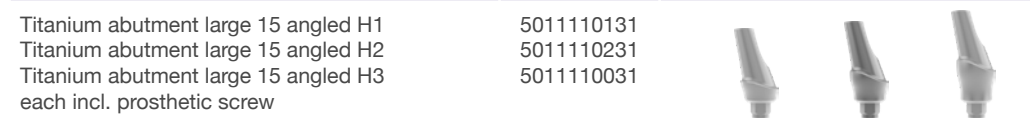
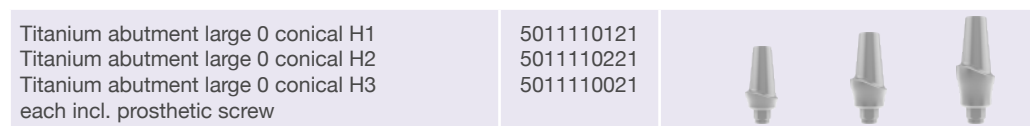
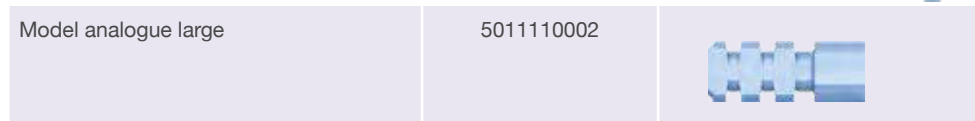
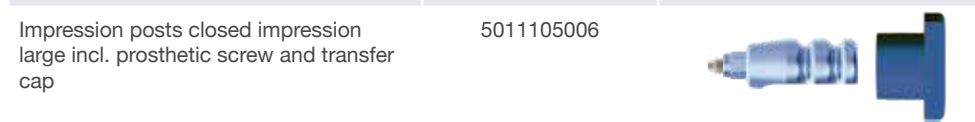
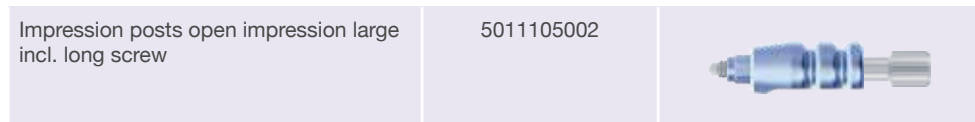
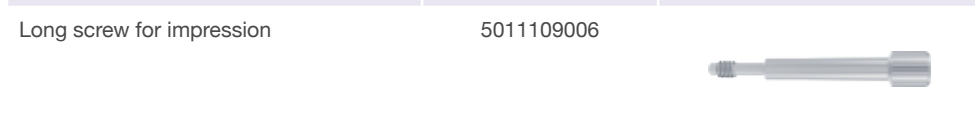
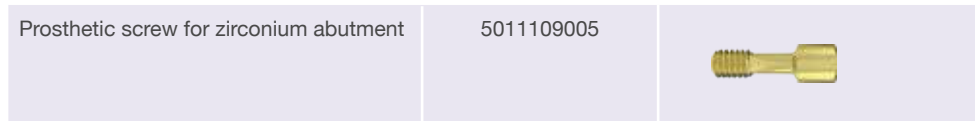
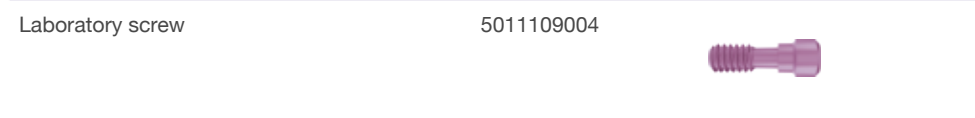
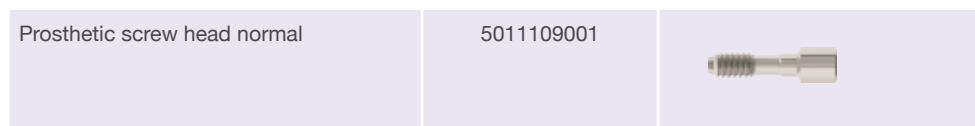

Large

mm	h1	h2	h3
h	9.6	11.0	13.0
hl	2.5	4.0	5.5
hb	1.5	2.5	4.5
d1	4.35		
d2	5.30		

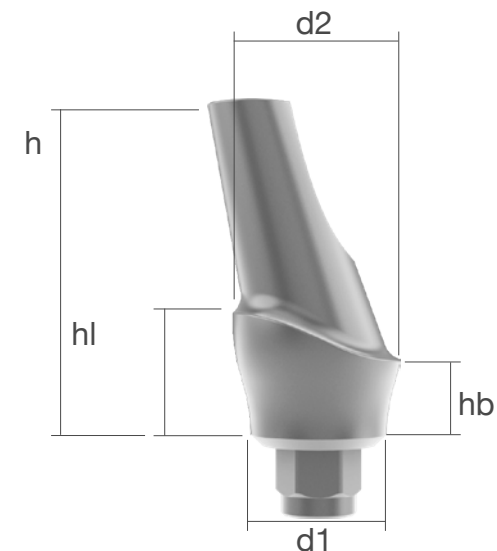

Gold-plastic abutment large without hexagon incl. prosthetic screw	5011510011	
Gold-plastic abutment large with hexagon incl. prosthetic screw	5011510012	
Plastic abutment large without hexagon incl. prosthetic screw	5011210010	
Plastic abutment large with hexagon incl. prosthetic screw	5011210011	
PEEK abutment for temporary treatment large incl. prosthetic screw	5011610102	
Titanium abutment for temporary treatment large incl. prosthetic screw	5011110102	
Ti adhesive base large incl. prosthetic screw	5011110060	

Platform - Large

for implants with a diameter of 5.0 mm and 6.0 mm

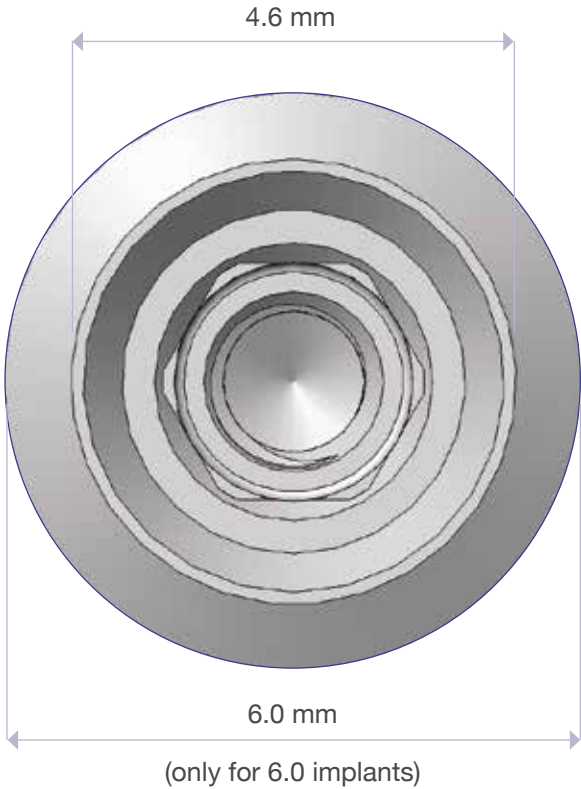

Ø5.0 and 6.0

MUA MultiUnit abutment

MU abutment S 0 H1	5011110420		0°
MU abutment S 0 H2	5011110421		
MU abutment S 17.5 H1 incl. prosthetic screw	5011110423		17.5
MU abutment S 17.5 H2 incl. prosthetic screw	5011110424		
MU abutment S 30 H1 incl. prosthetic screw	5011110426		30°
MU abutment S 30 H2 incl. prosthetic screw	5011110427		
MU abutment inserter	5012302022		
MU healing cap H1 incl. MU prosthetic screw	5011106100		
MU healing cap H2 incl. MU prosthetic screw	5011106101		
MU impression post open tray	5011110013		
MU impression post closed tray	5011110014		





Ø3.8 and 4.2

Platform - Standard For implants with a diameter of 3.8 mm and 4.2 mm

Prosthetic components single

MU scan connector PEEK incl. MU prosthetic screw	5011610000	
---	------------	---

MU lab analogue	5011110004	
-----------------	------------	---

MU inserter ratchet	5012302020	
---------------------	------------	---

MU prosthetic cap Ti incl. MU prosthetic screw	5011110012	
---	------------	---

MU prosthetic cap plastic incl. MU prosthetic screw	5011210020	
--	------------	--

Transfer cap single	5011205051	
---------------------	------------	---

Model analogue single	5011110003	
-----------------------	------------	---

Quick abutment cap gold with anti-rotation protection, allows another alloy to be cast into it	5011510051	
--	------------	---

Quick abutment cap titanium	5011110051	
-----------------------------	------------	---

Quick plastic cap single with anti-rotation protection, combustible	5011210052	
--	------------	---

Quick plastic cap single, combustible	5011210051	
--	------------	---

Prosthetic components hybrid prosthetics

EQUATOR kit



Available for all platforms with collar heights from 0.5 mm to 7.0 mm

The kit consists of:
 1x Metal casing
 4 plastic caps with different retention (violet-strong; white-standard; pink-soft; yellow-extra soft)
 1x Distance plate
 1x EQUATOR Profil implant abutment

Please ask us about the different options available.

Example for use



SPHERO BLOC kit

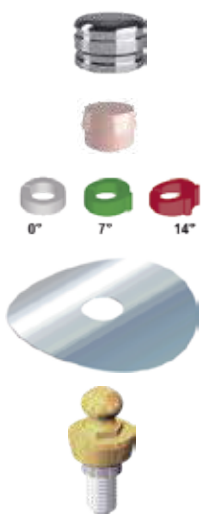

Available for all platforms with collar heights from 0.5 mm to 7.0 mm

The kit consists of:
 1x Metal casing
 2x Pink-soft plastic caps
 3x Alignment rings
 1x Distance plate
 1x SPHERO BLOCK implant abutment

Please ask us about the different options available.

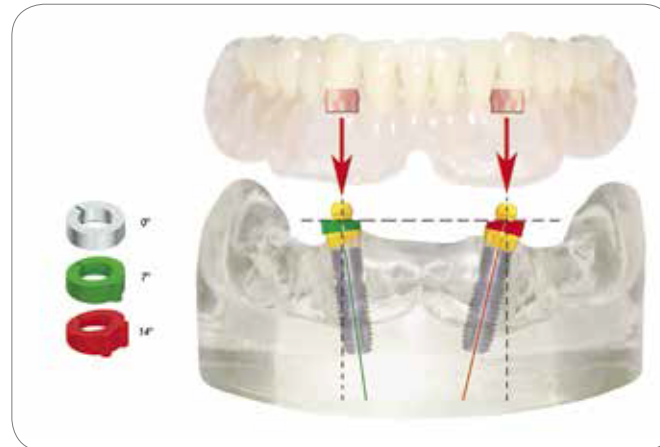

SPHERO FLEX kit

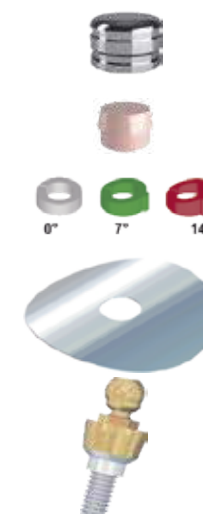

Available for all platforms with collar heights from 0.5 mm to 7.0 mm

The kit consists of:
 1x Metal casing
 2x Pink-soft plastic caps
 3x Alignment rings
 1x Distance plate
 1x SPHERO FLEX implant abutment

Please ask us about the different options available.

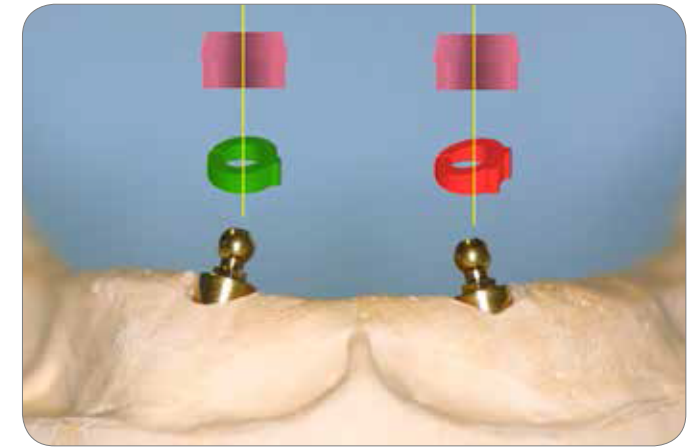

Replacement parts and tools

EQUATOR retention caps set
(1x metal casing, 1x laboratory cap, 4x retention caps
(1x each of extra-soft, soft, standard, strong))



EQUATOR retention caps (4x items)
STRONG, NORMAL, SOFT, EXTRA-SOFT

4x Laboratory caps



2x Metal casings



2x Impression casings



2x Laboratory analogues



Handheld abutment driver



Abutment driver for ISO ring torque ratchet for EQUATOR



Abutment driver for nylon caps



Abutment driver for SPERO BLOCK and SPERO FLEX



Abutment driver ISO ring torque ratchet for abutment driver



SPHERO retention caps (6x items)
STANDARD, SOFT, EXTRA-SOFT, VERY ELASTIC RETENTION, EXTRA-SOFT ELASTIC and GUMMY



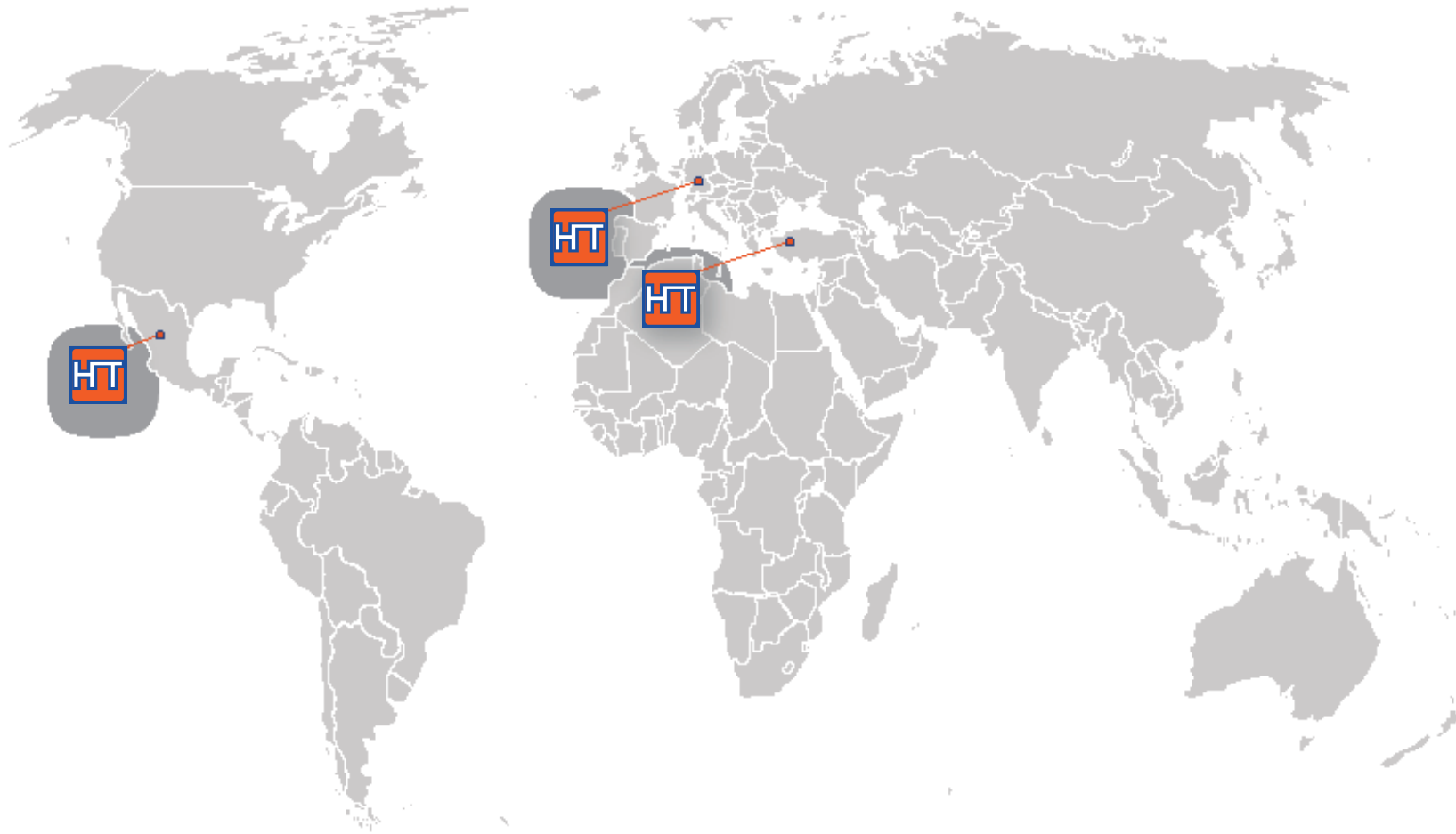

Lic. Agustin González S.

Oficina: 55-5780-3820
WhatsApp: 55-6788-4015



CE 0297



Made in Germany



www.ratioplant.com.mx
www.jucardental.com.mx